

Western Electric

307A Vacuum Tube

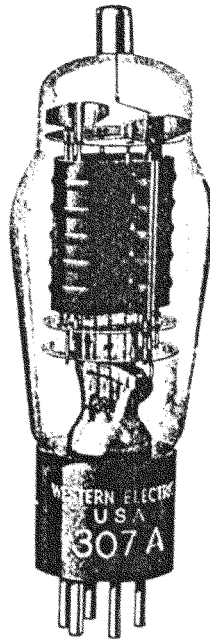

Classification—Moderate-power, filamentary suppressor-grid pentode

All three grids of the 307A tube are connected to separate base terminals.

Applications

Radio-frequency power amplifier

Suppressor-grid modulated amplifier

Frequency multiplier

Oscillator

Audio-frequency amplifier or modulator. The 306A tube gives better performance in this application and is preferable except where its different filament characteristics preclude its use.

Dimensions—Dimensions, outline diagrams of the tube and base, and the arrangement of the electrode connections to the base terminals are shown in Figures 1 and 2.

Base—Medium, five-pin base with bayonet pin. Small, metal cap plate terminal at the top of the bulb.

Socket—Standard, five-contact type, such as the Western Electric 141A socket.

Mounting Positions—Either vertical or horizontal. If mounted in a horizontal position, the plane of the filament, which is indicated in Figure 2, should be vertical.

Average Direct Interelectrode Capacitances

Control grid to plate	0.55 $\mu\text{f.}$
Control grid to filament, screen grid, and suppressor grid	15 $\mu\text{f.}$
Plate to filament, screen grid, and suppressor grid	12 $\mu\text{f.}$

Filament Rating

Filament voltage	5.5 volts, a.c. or d.c.
Nominal filament current	1.0 ampere

The filament of this tube is designed to operate on a voltage basis and should be operated at as near the rated voltage as is practicable. When alternating-current filament supply is used, the grid and plate returns should be connected to a center tap on the secondary of the filament transformer or to the center point of a suitable resistance connected across the filament terminals.

Characteristics—Plate current and screen-grid current characteristics of a typical 307A tube are shown in Figures 3 and 4, respectively, as functions of control-grid bias for several values of screen-grid and plate voltages and zero suppressor-grid voltage. The plate voltage for these characteristics is equal to the screen-grid voltage. Plate current and screen-grid current characteristics are shown as functions of plate voltage in Figures 5 and 6, respectively, for a screen-grid voltage of 200 volts and zero suppressor-grid voltage. Corresponding amplification factor, plate resistance, and transconductance characteristics are shown in Figures 7, 8 and 9, respectively. Plate current and screen-grid current characteristics are shown as functions of control-grid bias in Figures 10 and 11, respectively, for a plate voltage of 500 volts, a screen-grid voltage of 200 volts, and several values of suppressor-grid voltage.

All of these characteristics are for direct-current filament supply with the grid and plate voltages measured from the negative end of the filament. When alternating-current filament supply is used, the same characteristics may be applied if 3.2 is added to the numerical value of each control-grid bias.

Limiting Conditions For Safe Operation

	Class A Amplifier	*Class C Amplifier or Oscillator	**Class B or Suppressor- Modulated Class C Amplifier
Maximum direct plate voltage.	500	500	500 volts
Maximum direct screen-grid voltage.	300	250	250 volts
Maximum direct plate current.	60	60	45 milliamperes
Maximum direct screen-grid current.	25	25	25 milliamperes
Maximum direct control-grid current.	—	7	7 milliamperes
Maximum plate dissipation.	15	15	15 watts
Maximum screen-grid dissipation.	6	6	6 watts
Maximum instantaneous control-grid voltage on positive swing of input	—	+30	+30 volts

*Key-down conditions for intermittent service such as telegraphy.

For continuous operation the direct plate current should be limited to 45 milliamperes.

**Carrier conditions for use with a modulation factor up to 1.0.

Because of secondary emission effects, the suppressor grid should not be driven more than 20 volts positive except where the resistance in the suppressor-grid circuit is small.

Operating Conditions and Output

Class A—Audio-Frequency Amplifier or Modulator.

Permissible operating conditions for Class A operation are included within the area, A B C D E, in Figure 3. Nominal performance data are given in the table on page 3 for typical operating conditions represented by selected points within this area. It is assumed that the plate voltage for every operating condition is equal to the screen-grid voltage. Other plate voltages, however, are per-

missible within the limits set down in the preceding section. A less severe operating condition should be selected in preference to a maximum operating condition wherever possible. The life of the tube at maximum conditions may be shorter than at less severe conditions.

The performance data include the maximum fundamental power output in watts and the maximum levels of the second and third harmonics in decibels below the fundamental for the recommended values of load resistance and the indicated range of input voltages. In designing the 307A tube for optimum characteristics as a suppressor-grid modulated, Class C amplifier, its Class A amplifier characteristics have been sacrificed to some extent. It will deliver approximately the same maximum power output as the 306A tube under similar Class A operating conditions, but the harmonic levels for comparable outputs are somewhat higher.

TABLE

Plate Voltage	Screen Grid Voltage	Suppressor Grid Voltage	Control-Grid Bias	Plate Current	Screen Grid Current	Load Resistance	Input Voltage Range	Maximum Power Output	Maximum Second Harmonic	Maximum Third Harmonic
Volts	Volts	Volts	Volts	Milli-amperes	Milli-amperes	Ohms	Peak Volts	Watts	db	db
200	200	0	-15	36.5	3.4	4000	0-15	2.9	23.5	24
250	250	0	-20	50	4.0	4000	0-20	5.7	24	23.5
*300	300	0	-30	43	2.6	4500	0-30	9.1	21	17.5

*Maximum operating condition.

Curves showing the variation of power output and second and third harmonic levels for the three operating conditions given in the table are shown in Figures 12, 13 and 14, respectively.

Class C—Radio-Frequency Power Amplifier, Suppressor-Grid Modulated Amplifier, and Oscillator. Typical operating conditions and output.

	Suppressor-Modulated Class C Amplifier	Unmodulated Class C Amplifier or Oscillator
	Note 1	Note 2
Direct plate voltage	500	500 volts
Direct screen-grid voltage (approx.)	200	250 volts
Screen-grid circuit resistance	14000	20000 ohms
Total control-grid bias (approx.)	-35	-35 volts
Control-grid circuit resistance	10000	10000 ohms
Fixed control-grid bias	-20	-20 volts
Suppressor-grid bias	-50	0 volts
R-F control-grid voltage	50	50 peak volts
Direct plate current	40	60 milliamperes
Direct screen-grid current	20	13 milliamperes
Direct control-grid current	1.5	1.4 milliamperes
A-F suppressor-grid voltage	50	0 peak volts
Effective load resistance	4000	5000 ohms
Carrier power output	6	20 watts
Power output on a-f peaks	24	— watts

Note 1—Carrier conditions for use with modulation factors up to 1.0.

Note 2—Conditions permissible only for intermittent service, such as telegraphy.

It is recommended that the screen-grid voltage be obtained from the plate voltage by inserting a resistance in series with the screen grid and plate voltage, and that part of the control-grid bias also be obtained from the voltage drop produced by the control-grid current flowing through a resistance. With this arrangement, using the indicated values of resistance, the output power is

almost independent of carrier input over a wide range of carrier input voltages, the distortion of the signal wave in the modulator application is minimized, and the risk of damaging the tube by overload while making circuit adjustments is reduced.

A radio-frequency output current characteristic of a typical 307A tube is shown in Figure 15 as a function of suppressor-grid voltage for a constant impressed radio-frequency control-grid voltage of 50 peak volts. Corresponding plate current, screen-grid current, control-grid current, and suppressor-grid current characteristics are given in Figure 16. These characteristics correspond to the first column of operating conditions listed above, except that the suppressor-grid voltage is treated as a variable.

High-Frequency Ratings

It is permissible to use the 307A tube at full rating for operating frequencies up to 40 megacycles and at reduced ratings up to 70 megacycles. Ratings for these two frequencies are as follows:

	<u>40 Megacycles</u>	<u>70 Megacycles</u>
Maximum direct plate voltage.....	500	300 volts
Maximum direct plate current		
For Class C telegraphy (intermittent).....	60	45 milliamperes
For all other classes of service.....	45	45 milliamperes

For intermediate frequencies, proportionate ratings are applicable. The object in reducing the ratings is to limit charging currents and dielectric losses, which produce heat in the leads and glass of the tube at high frequencies.

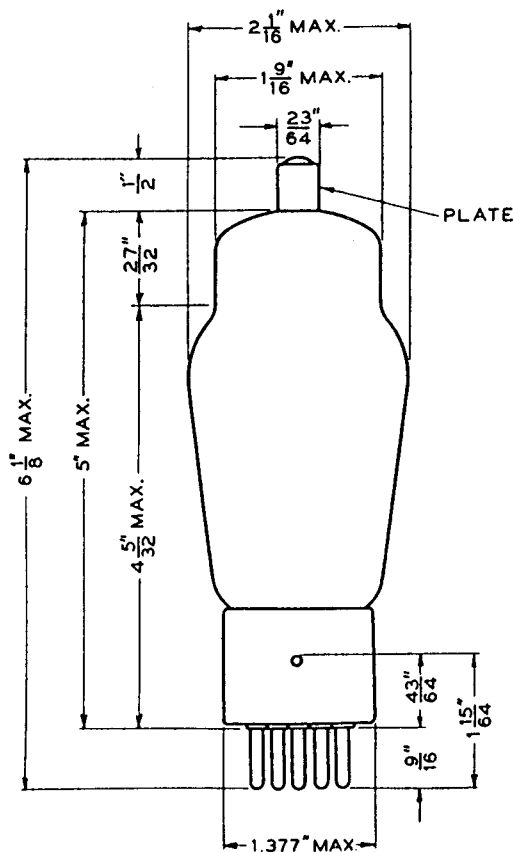

FIG. 1

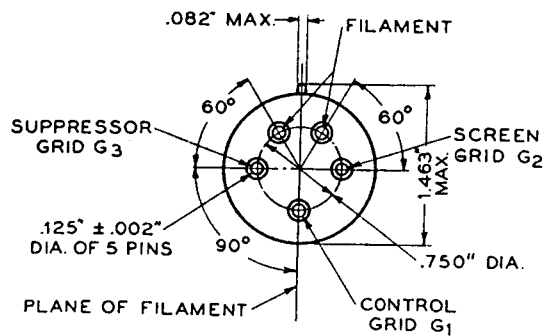

FIG. 2

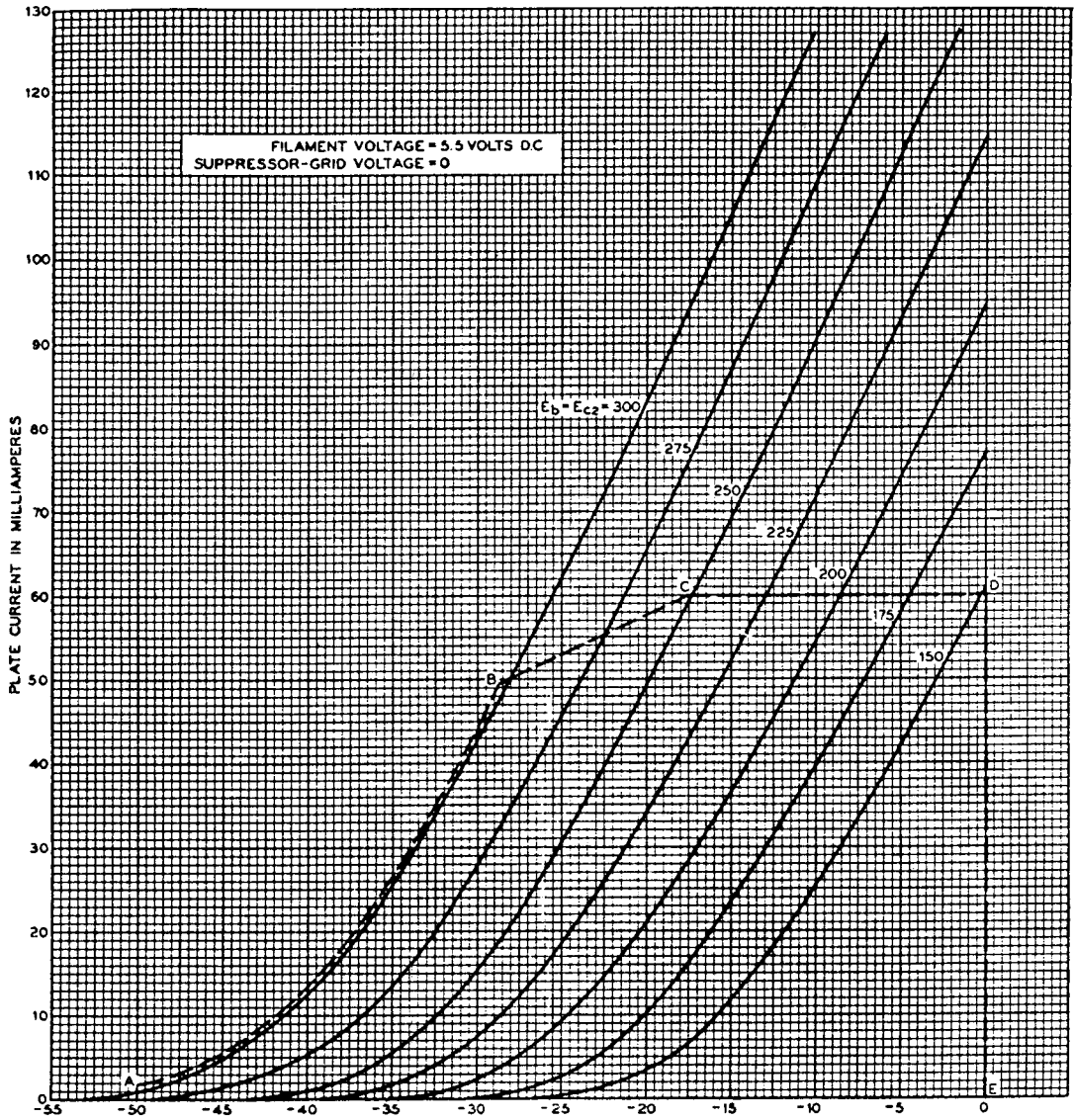

FIG. 3

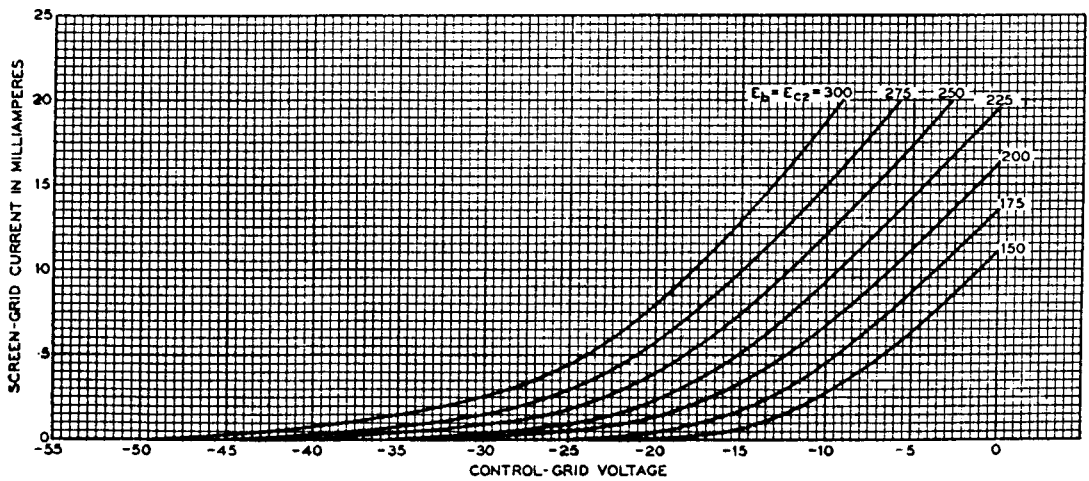

FIG. 4

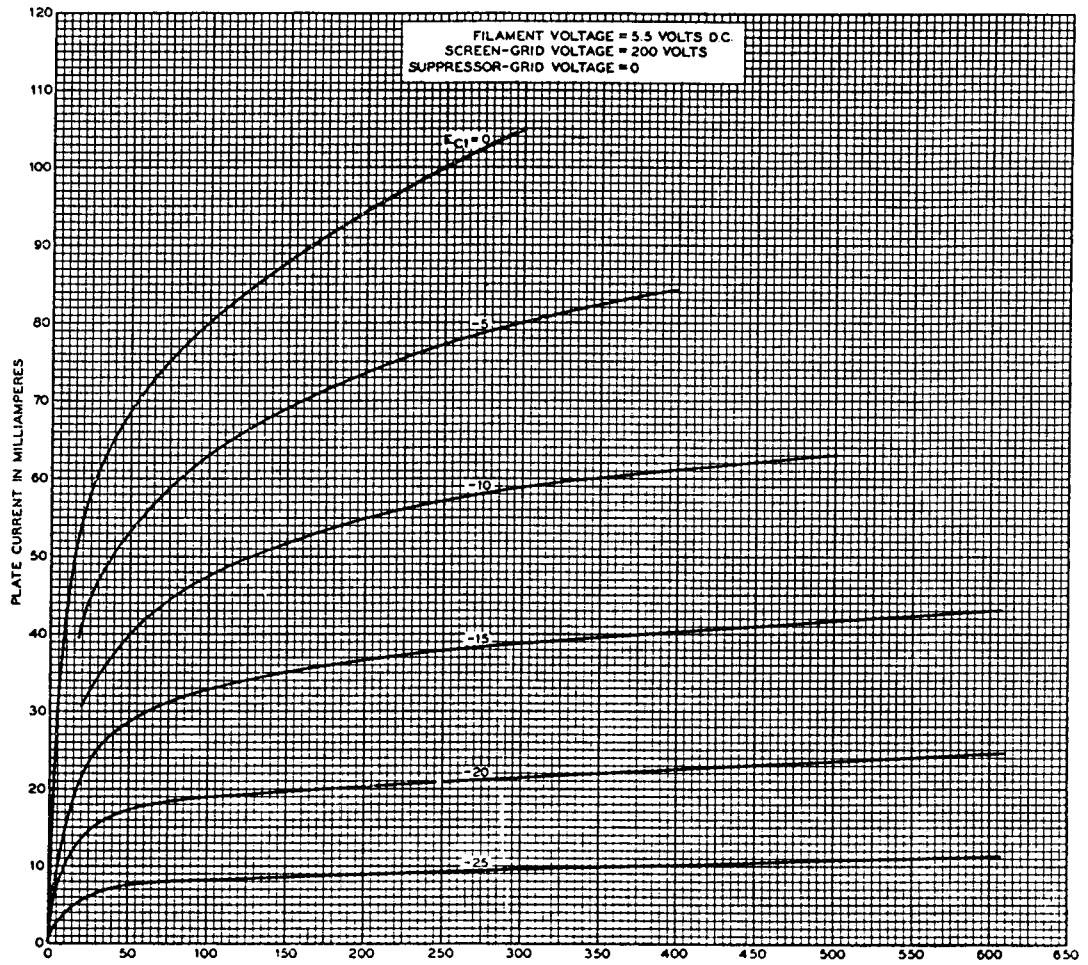

FIG. 5

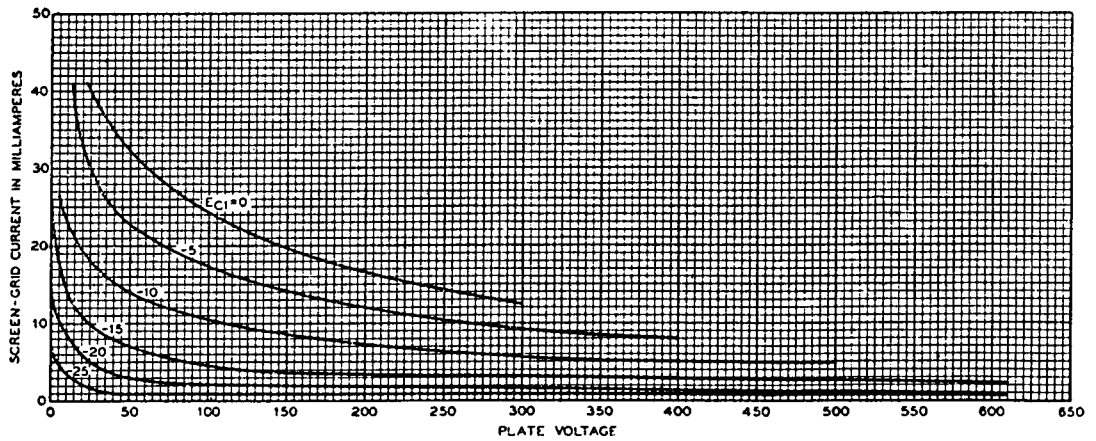

FIG. 6

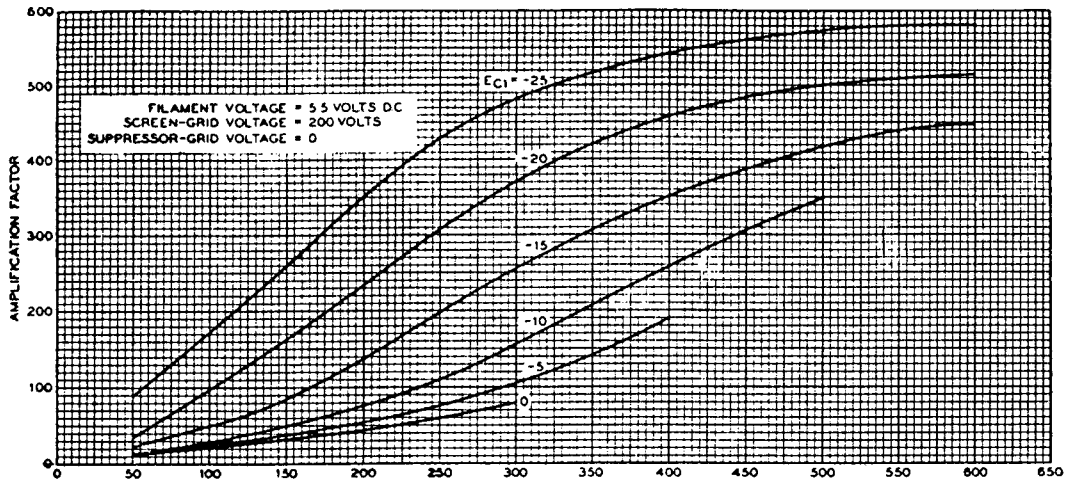

FIG. 7

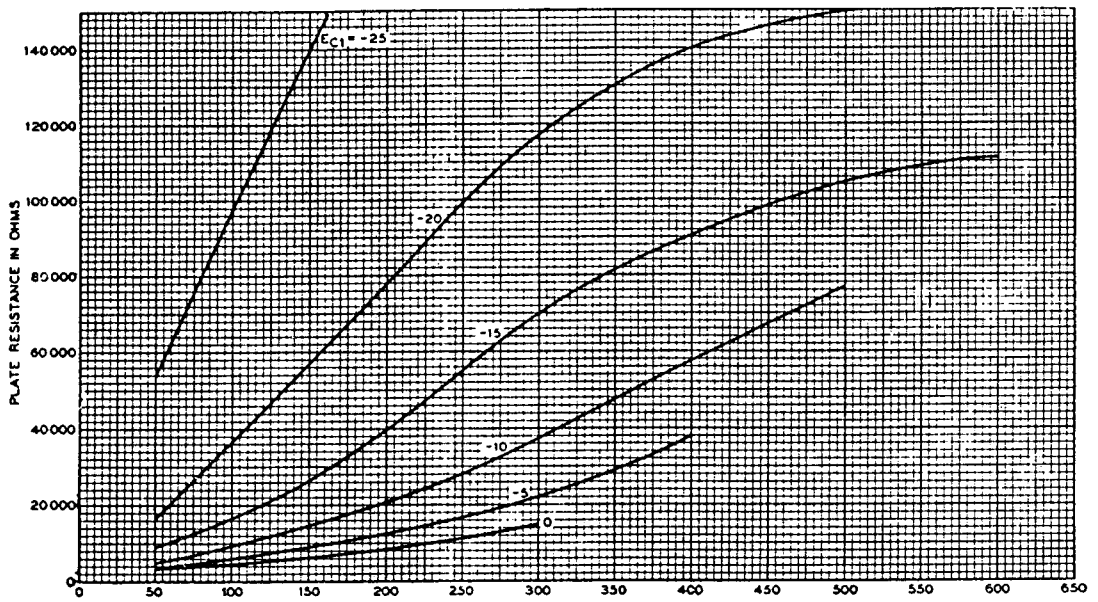

FIG. 8

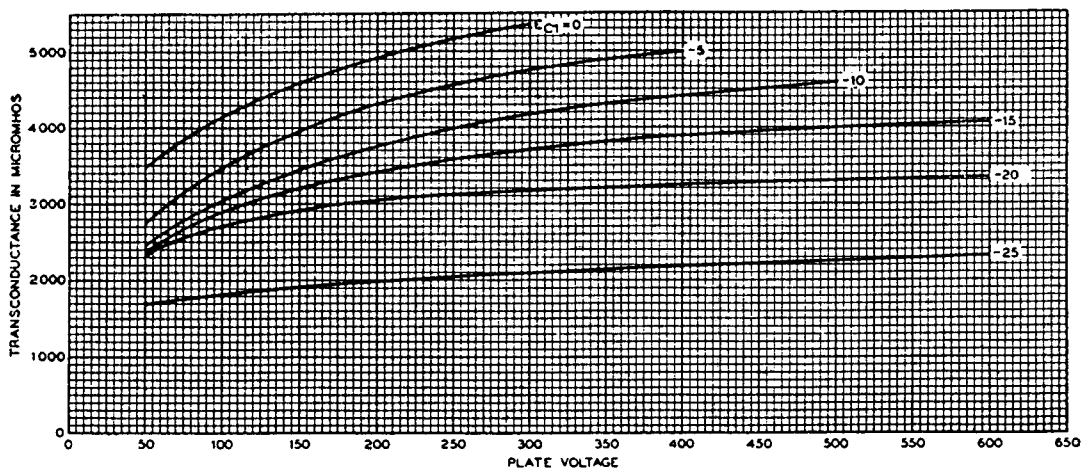

FIG. 9

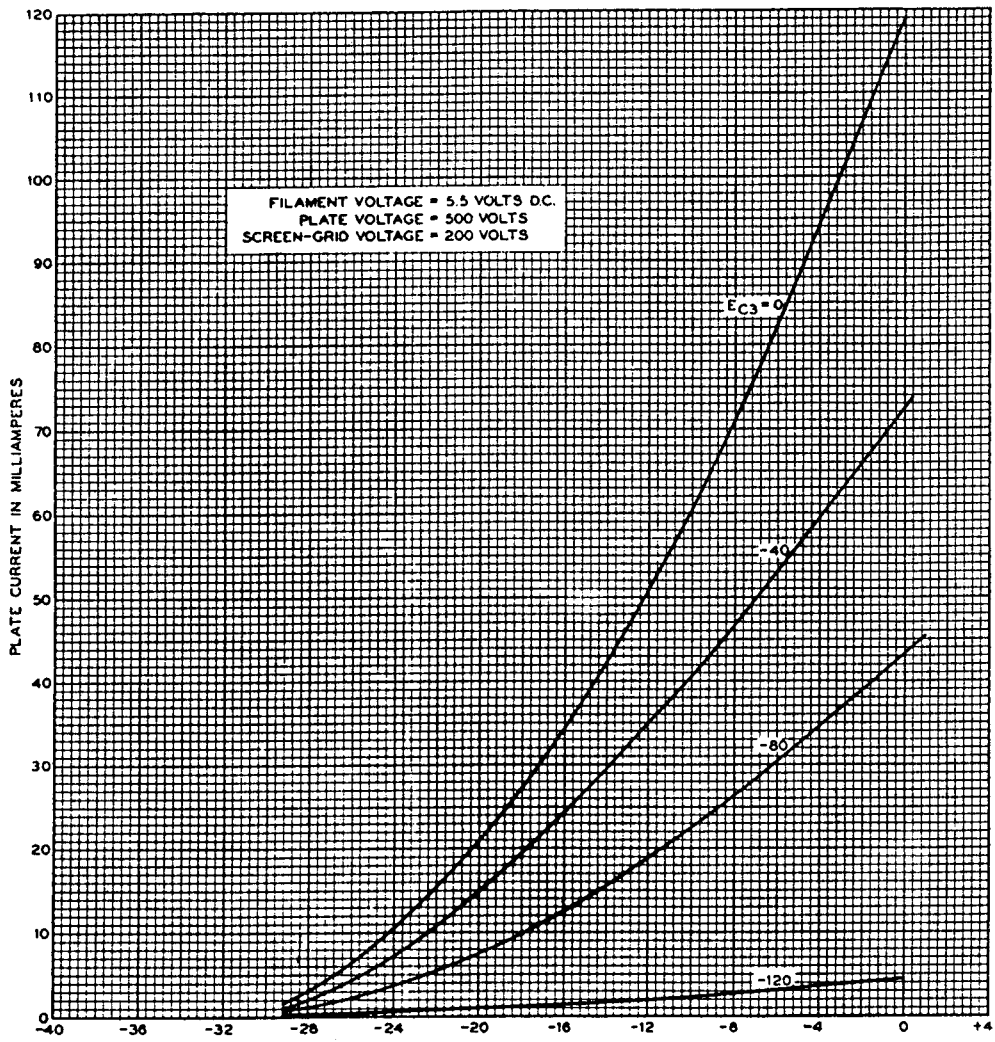

FIG. 10

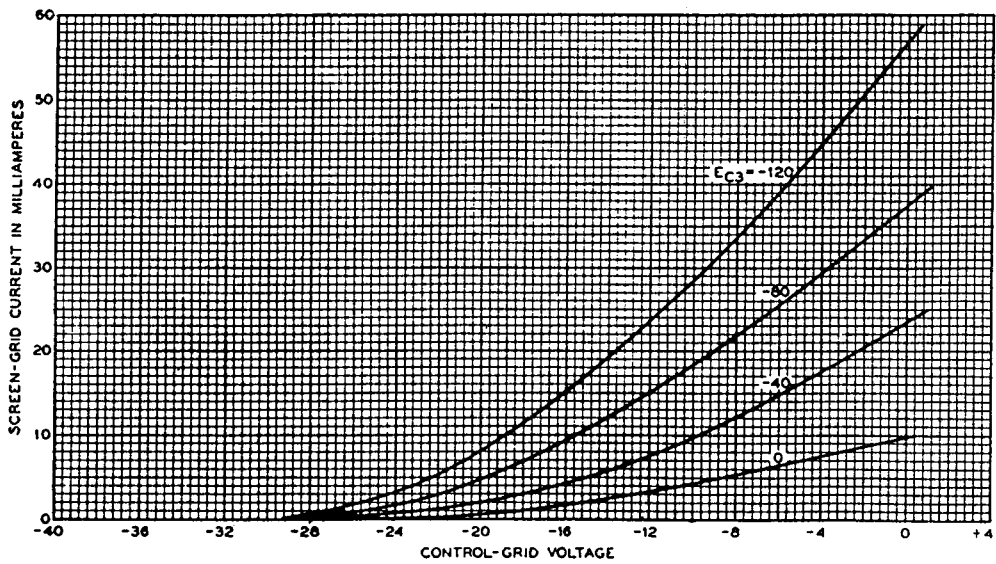

FIG. 11

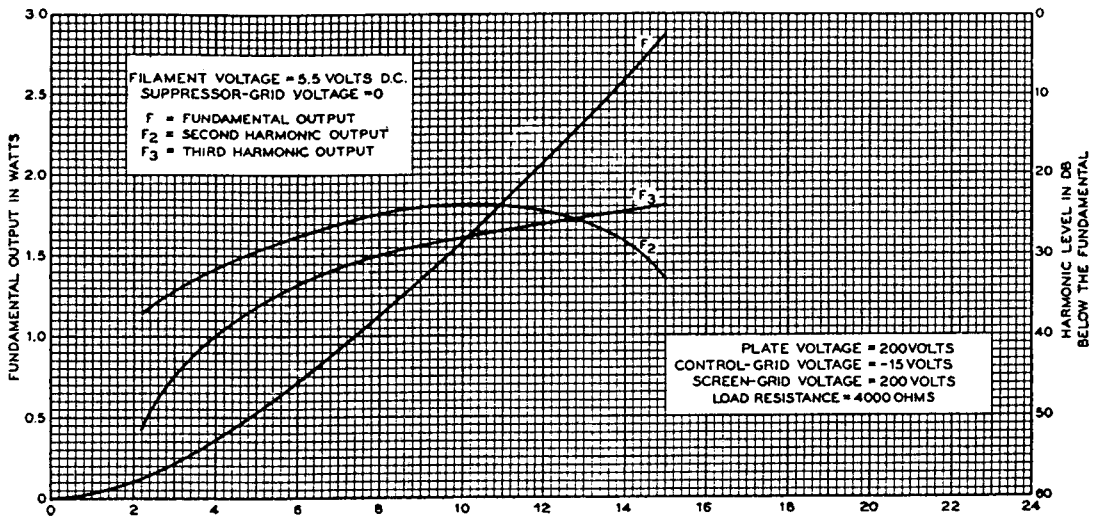

FIG. 12

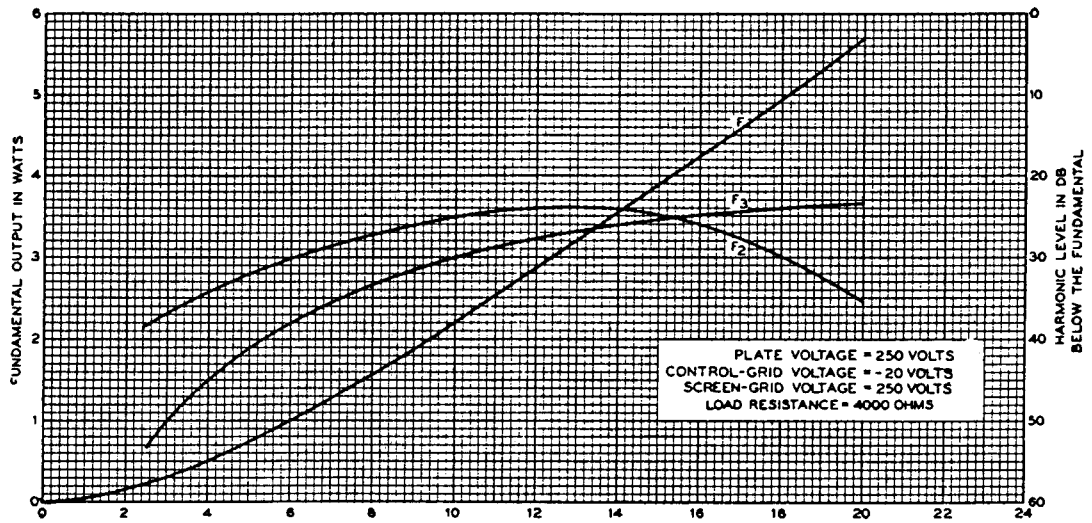

FIG. 13

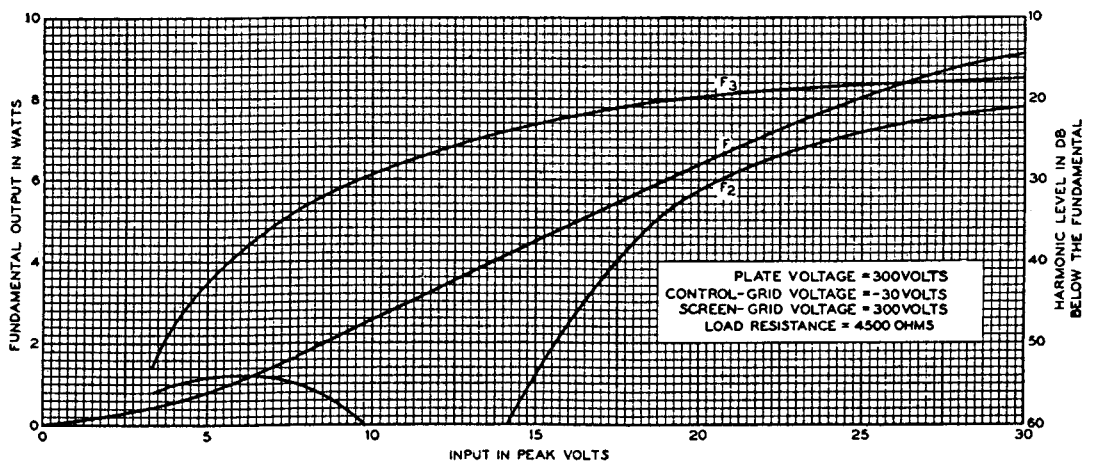

FIG. 14

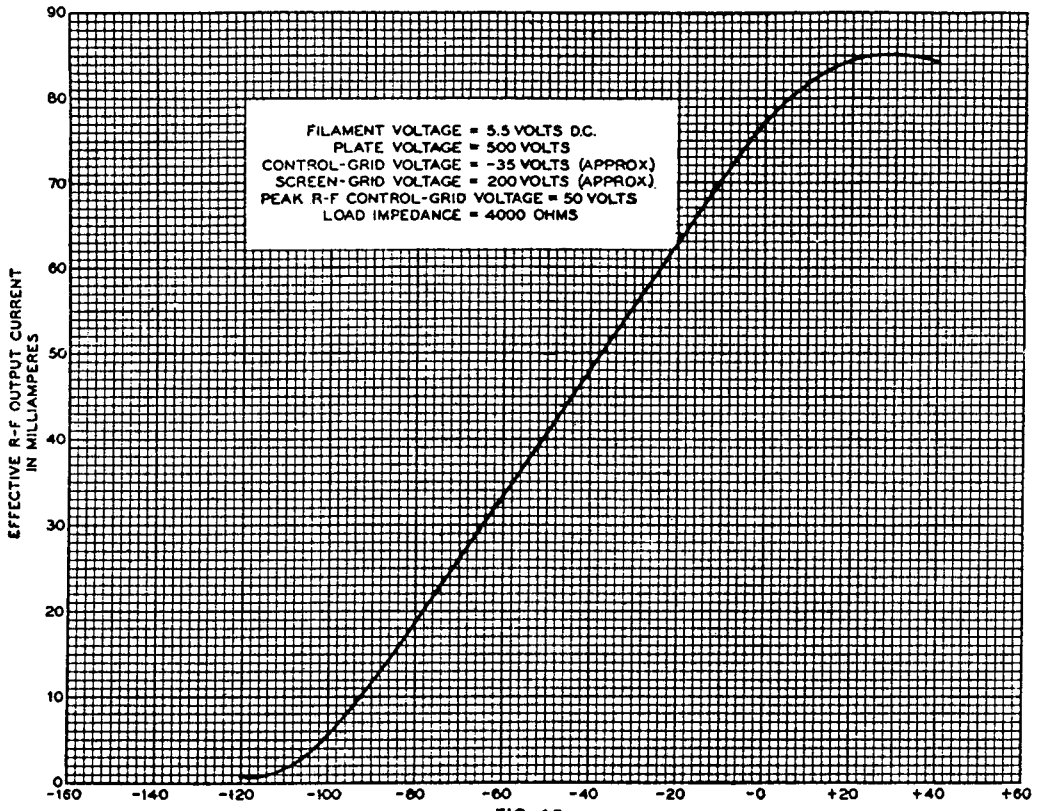

FIG. 15

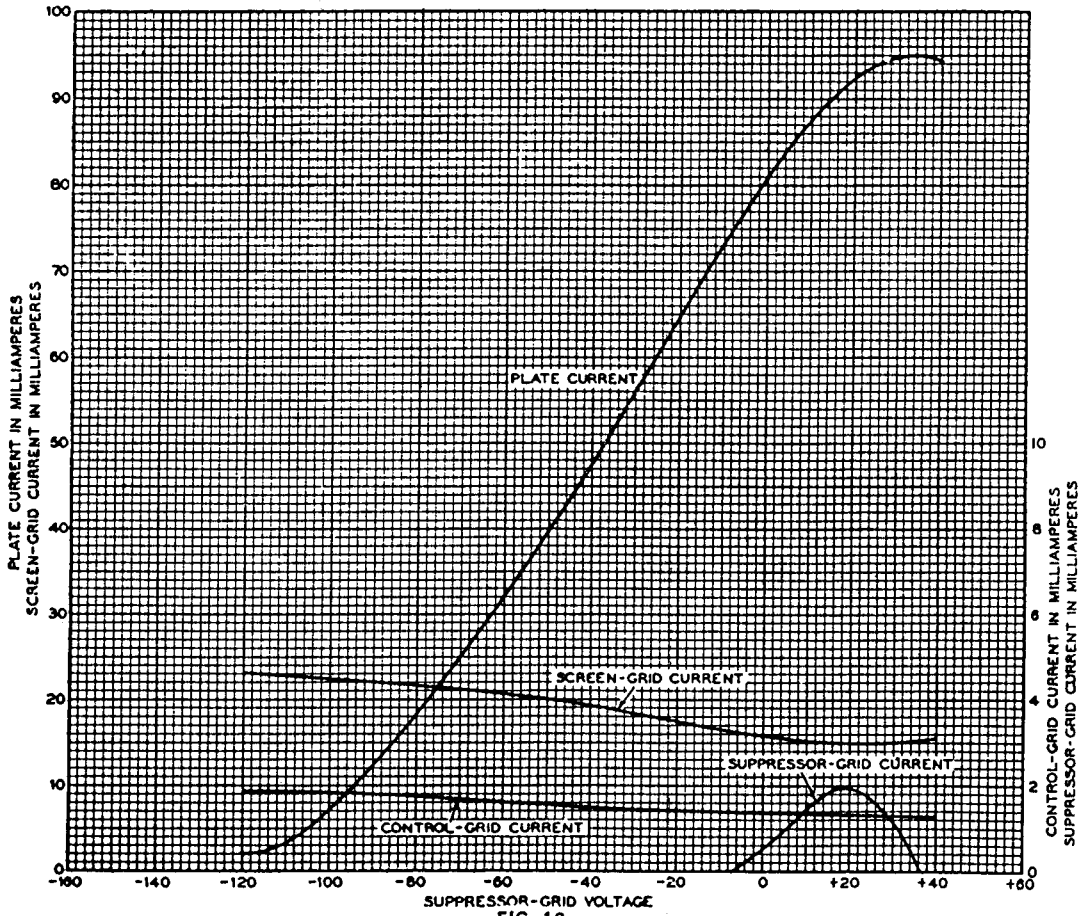

FIG. 16