



Completing the noisy circuit

Systems of feedback in models of dysarthria

Frank Rudzicz
Scientist, Toronto Rehabilitation Institute
Assistant professor, Department of Computer Science
University of Toronto

SPASR workshop, 30 August 2013, Lyon France

Studying how systems break down

- Observing how **closed systems** *fail* can be a **valuable method** in discovering how those systems **work**.
- **Paul Broca** (left) discovered, in 1861, that a **lesion** in the **left** ventro-posterior **frontal lobe** caused **expressive aphasia**.
- This was the first **direct** evidence that **language function** was **localized**.
 - It hinted at a **mechanistic** view of **speech production**.

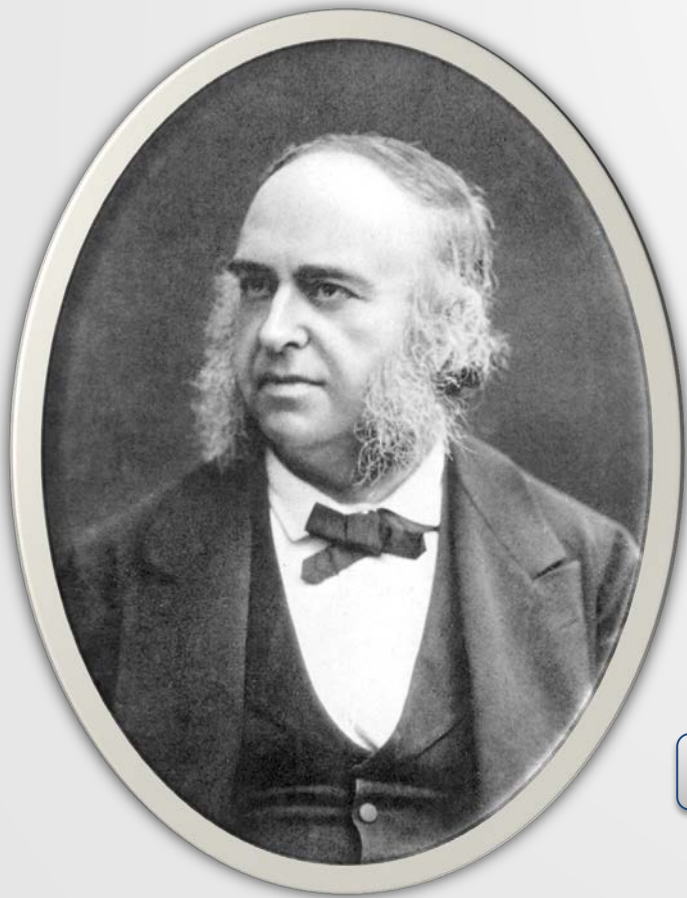

Broca's area

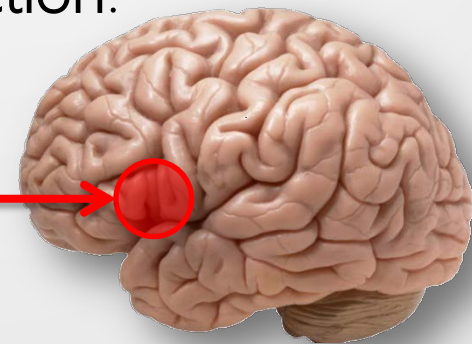

Dysarthria

Neuro-motor articulatory disorders resulting in unintelligible speech.

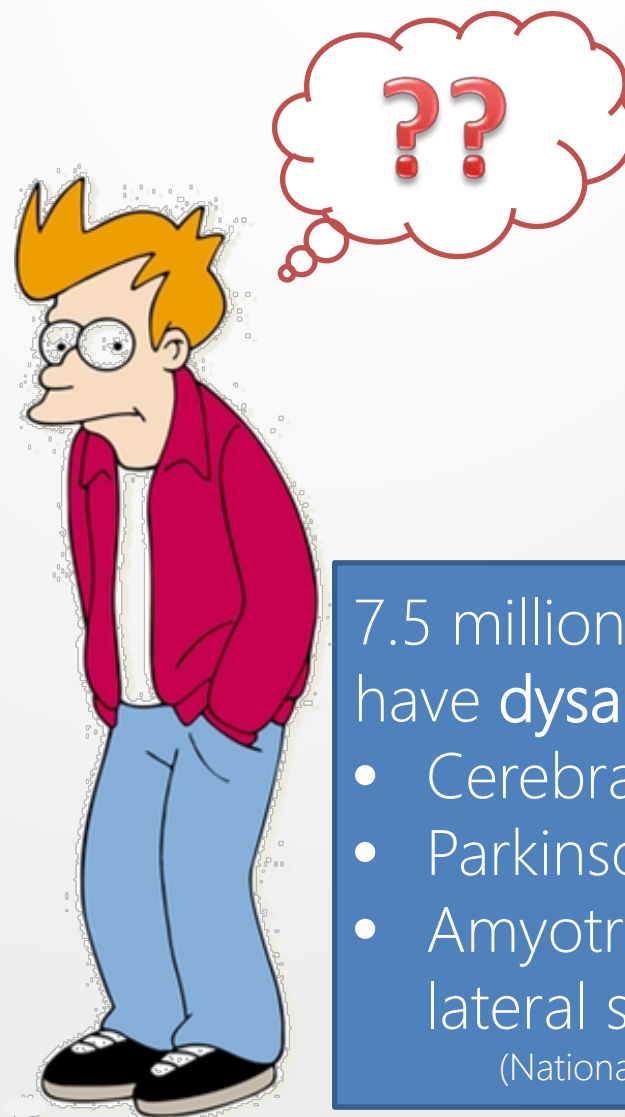
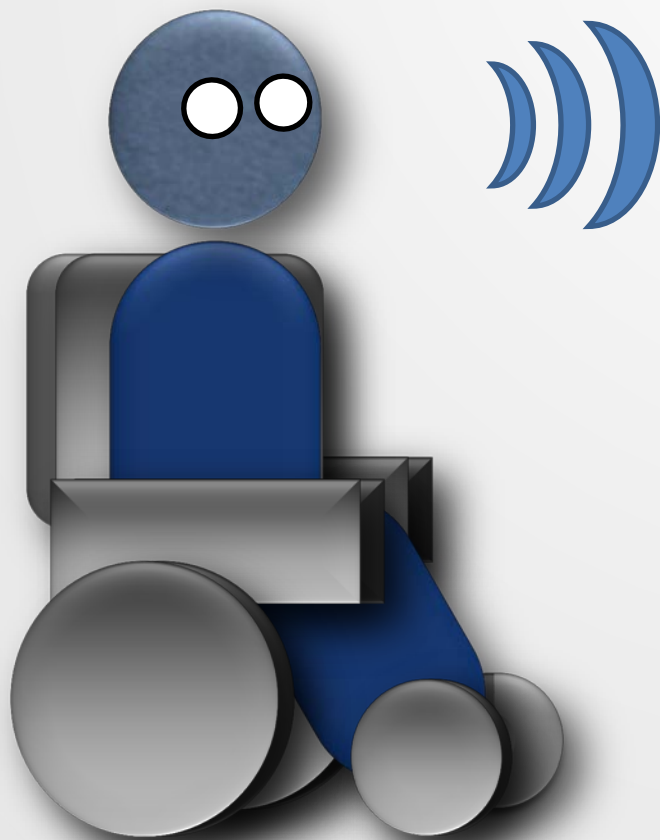

7.5 million Americans have **dysarthria**

- Cerebral palsy,
- Parkinson's,
- Amyotrophic lateral sclerosis)

(National Institute of Health)

Nosology of dysarthria

- **Types** of dysarthria are related to **specific sites** in the subcortical nervous system.

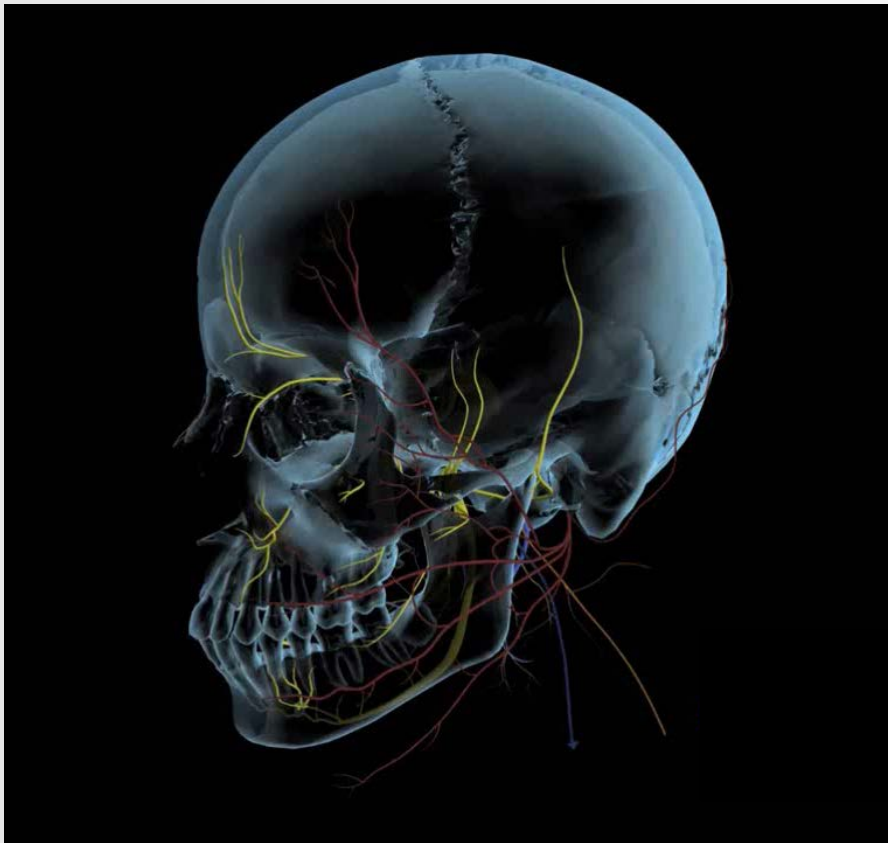

Type	Primary lesion site
Ataxic	Cerebellum or its outflow pathways
Flaccid	Lower motor neuron (≥ 1 cranial nerves)
Hypo-kinetic	Basal ganglia (esp. substantia nigra)
Hyper-kinetic	Basal ganglia (esp. putamen or caudate)
Spastic	Upper motor neuron
Spastic-flaccid	Both upper and lower motor neurons

(After Darley *et al.*, 1969)

Characteristics of dysarthria

	Ataxic	Flaccid	Hypo-kinetic	Hyper-kinetic, chorea	Hyper-kinetic, dystonia	Spastic	Spastic-flaccid (ALS)
Monopitch							
Harshness							
Imprecise consonants							
Mono-loud							
Distorted vowels							
Slow rate							
Short phrases							
Hypernasal							
Prolonged intervals							
Low pitch							
Inappropriate silences							
Variable rate							
Breathy voice							
Strain-strangled voice							
...							

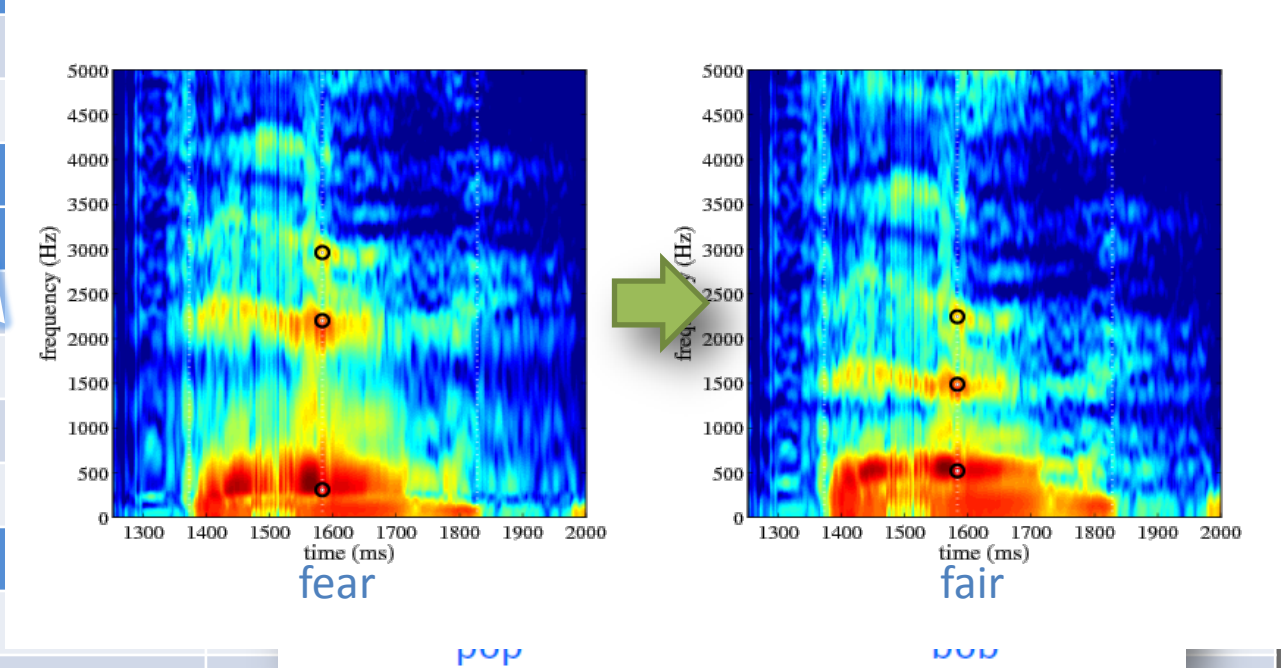
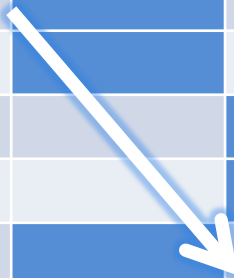

Dysarthria

The **broader** neuro-motor deficits associated with dysarthria can make **traditional** human-computer interaction difficult.

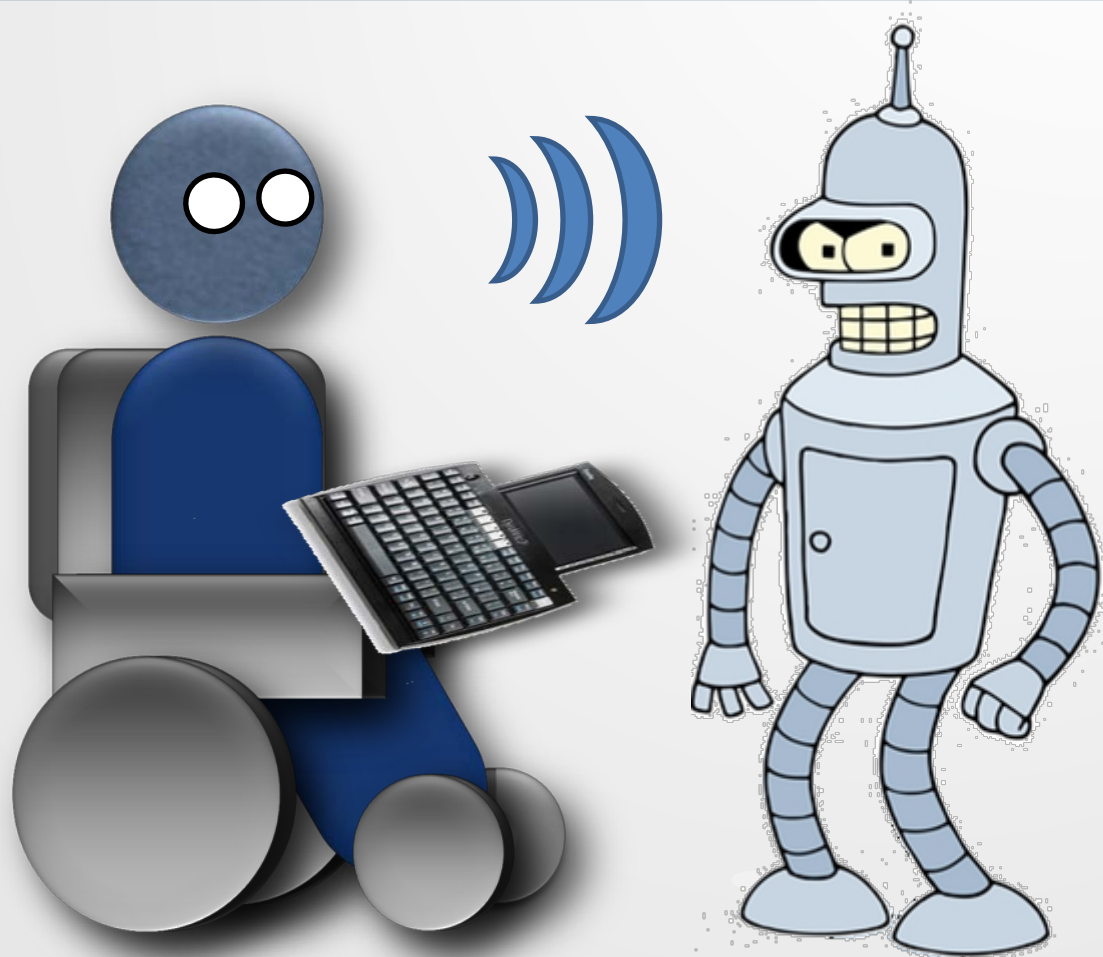

Can we use
ASR for
dysarthria?

Accounting for aspects of dysarthria

- Ergodic HMMs can be **robust** against recurring **pauses**, and **non-speech** events.
- Polur and Miller (2005) replaced GMM densities with neural networks (after Jayaram and Abdelhamied, 1995), further increasing accuracy.

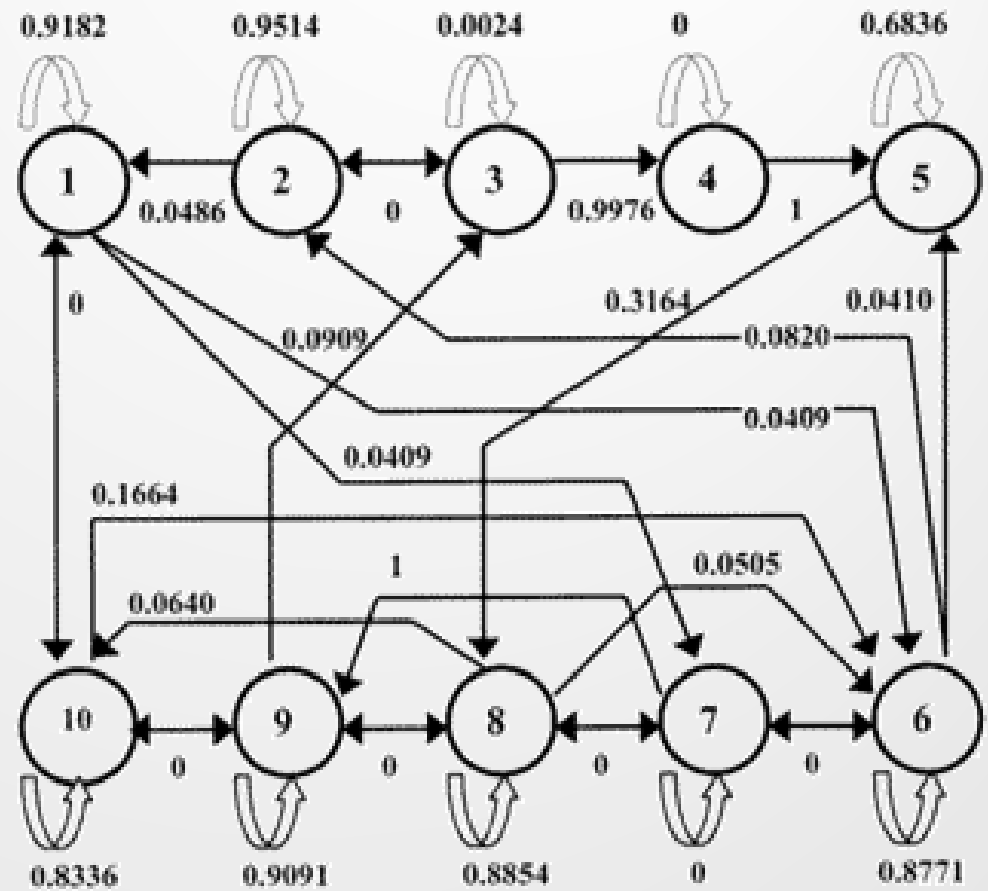
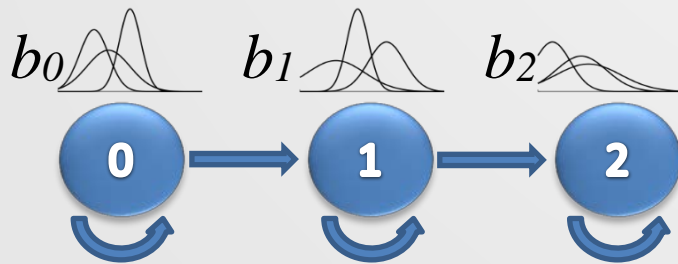

(From Polur and Miller., 2005)

Adjusting to the individual speaker

84.9% →

Traditional ASR
Speaker-
dependent
Speaker-
retrained

3.1% →

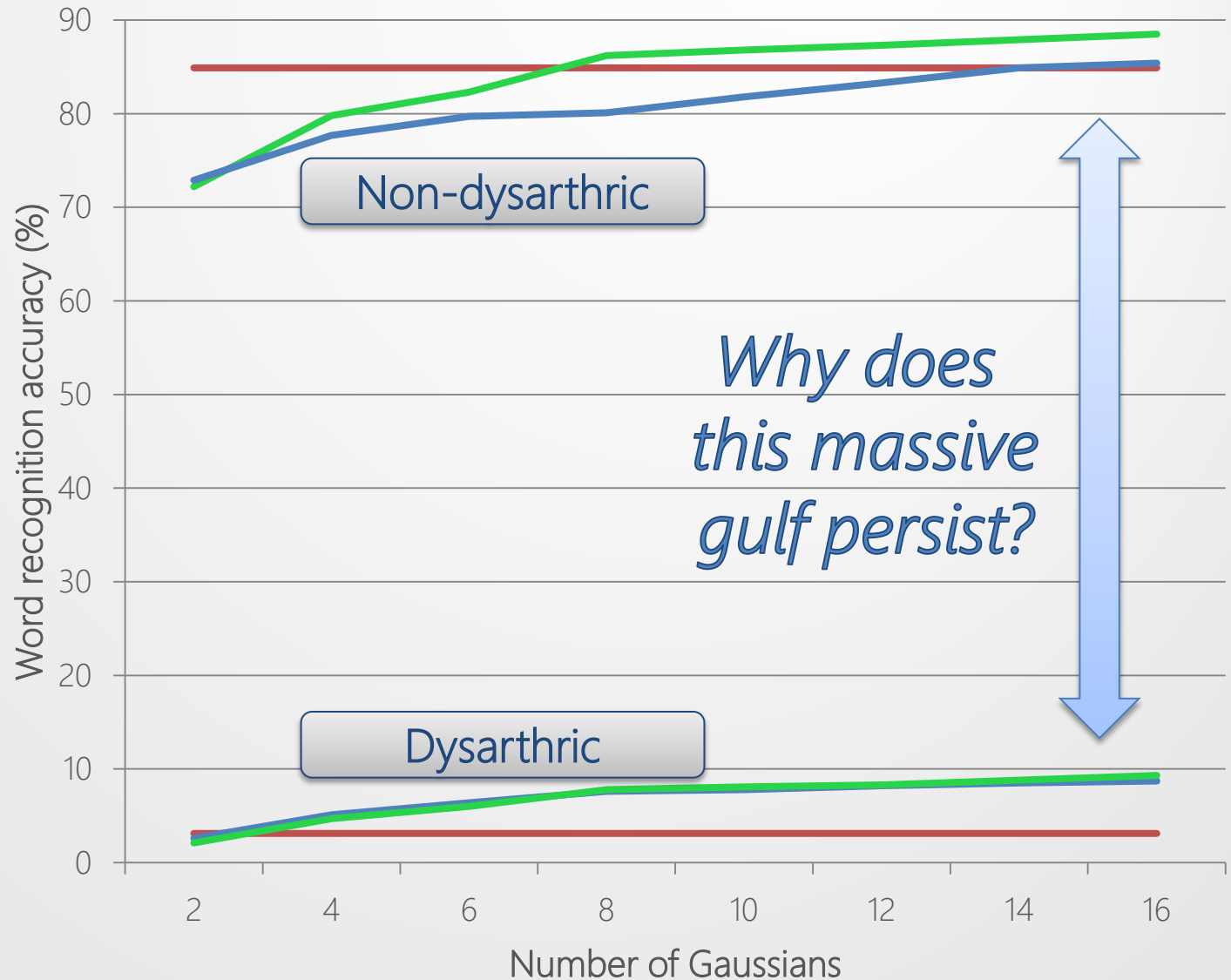

Acoustic ambiguity

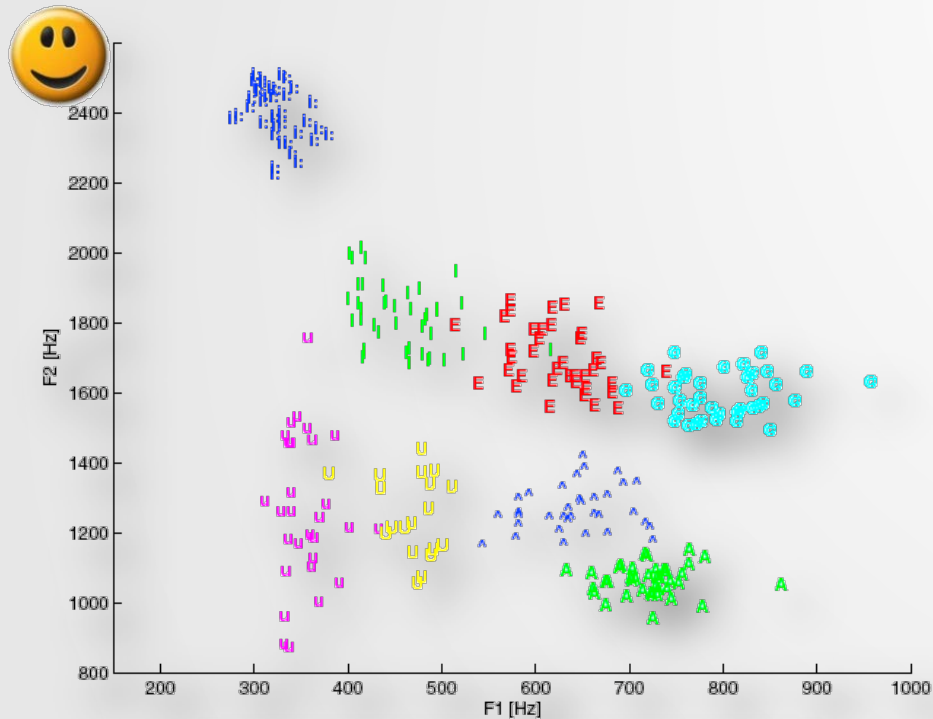

Non-dysarthric

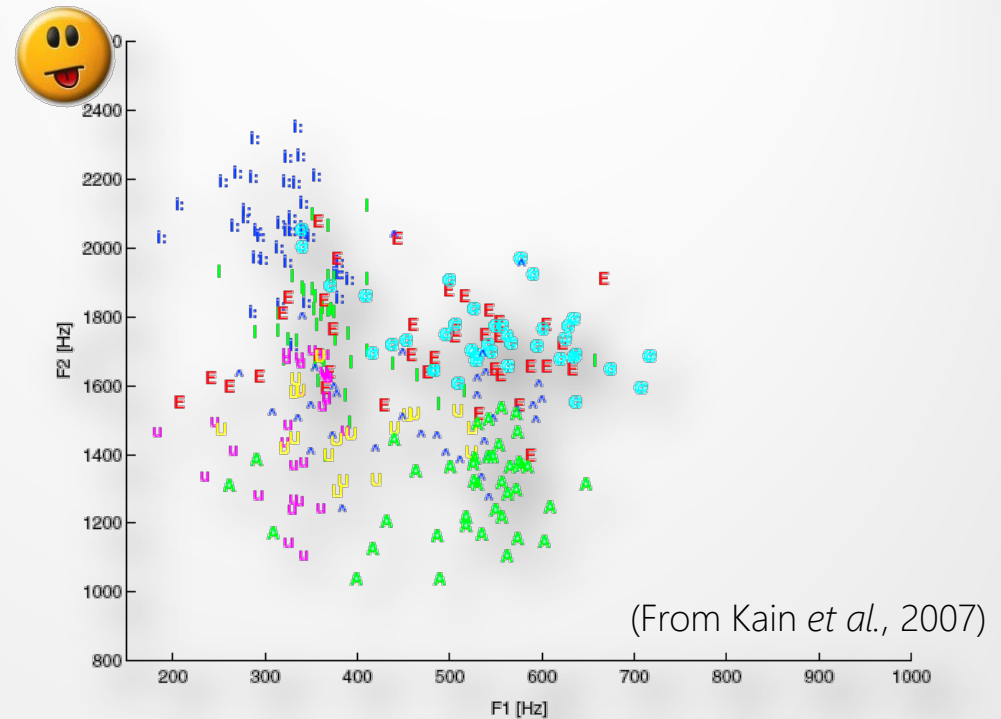

Dysarthric

(From Kain *et al.*, 2007)

This acoustic behaviour is indicative of underlying articulatory behaviour.

The TORGO database

- TORGO was built to train augmented ASR systems.
 - 9 subjects with cerebral palsy, 9 matched controls.
 - Each reads 500—1000 prompts over 3 hours that cover phonemes and articulatory contrasts (e.g., *meat* vs. *beat*).
 - Electromagnetic articulography (and video) track points to <1 mm error.

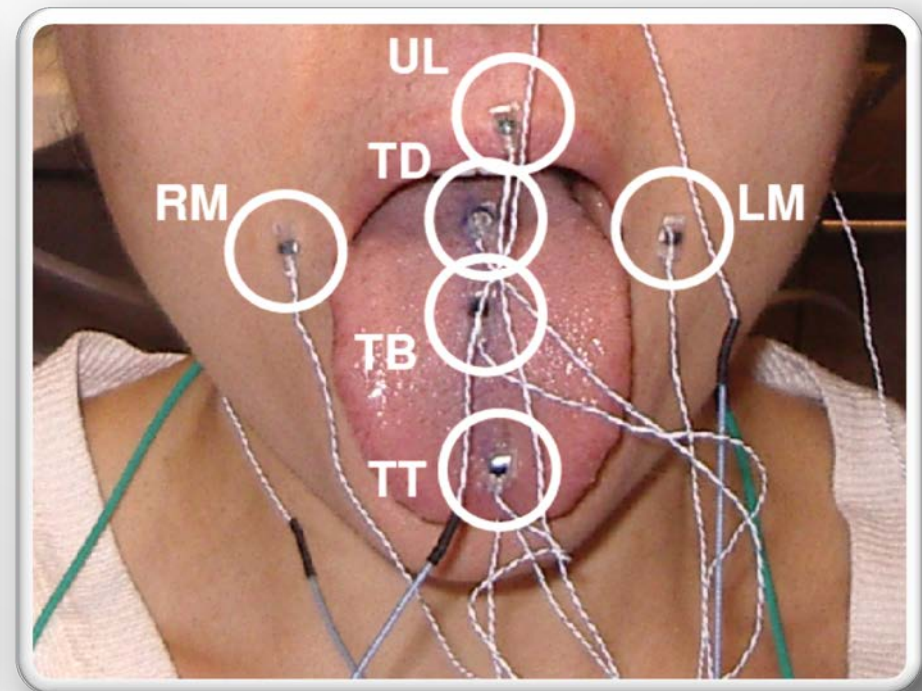
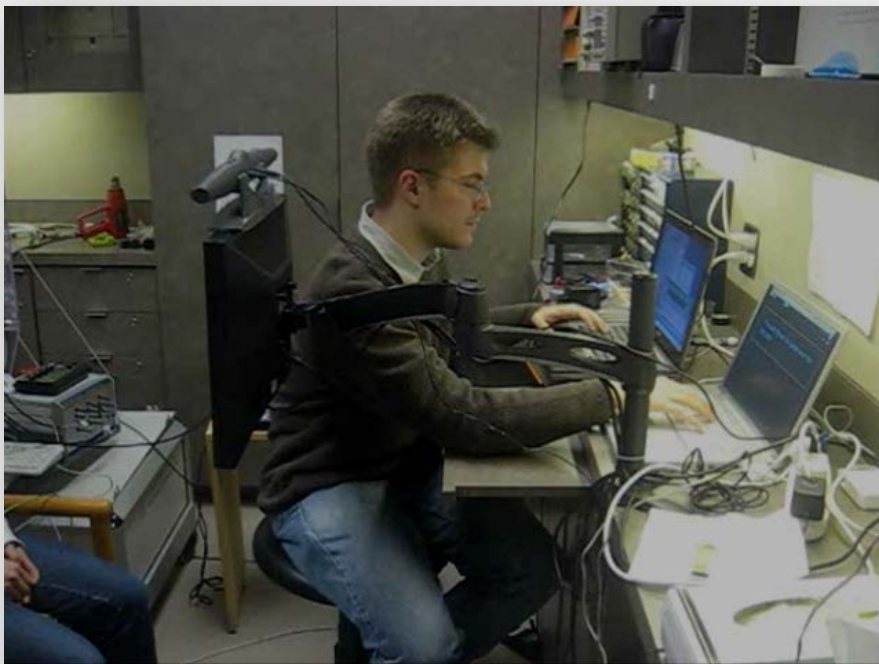

Vowel durations in TORGO

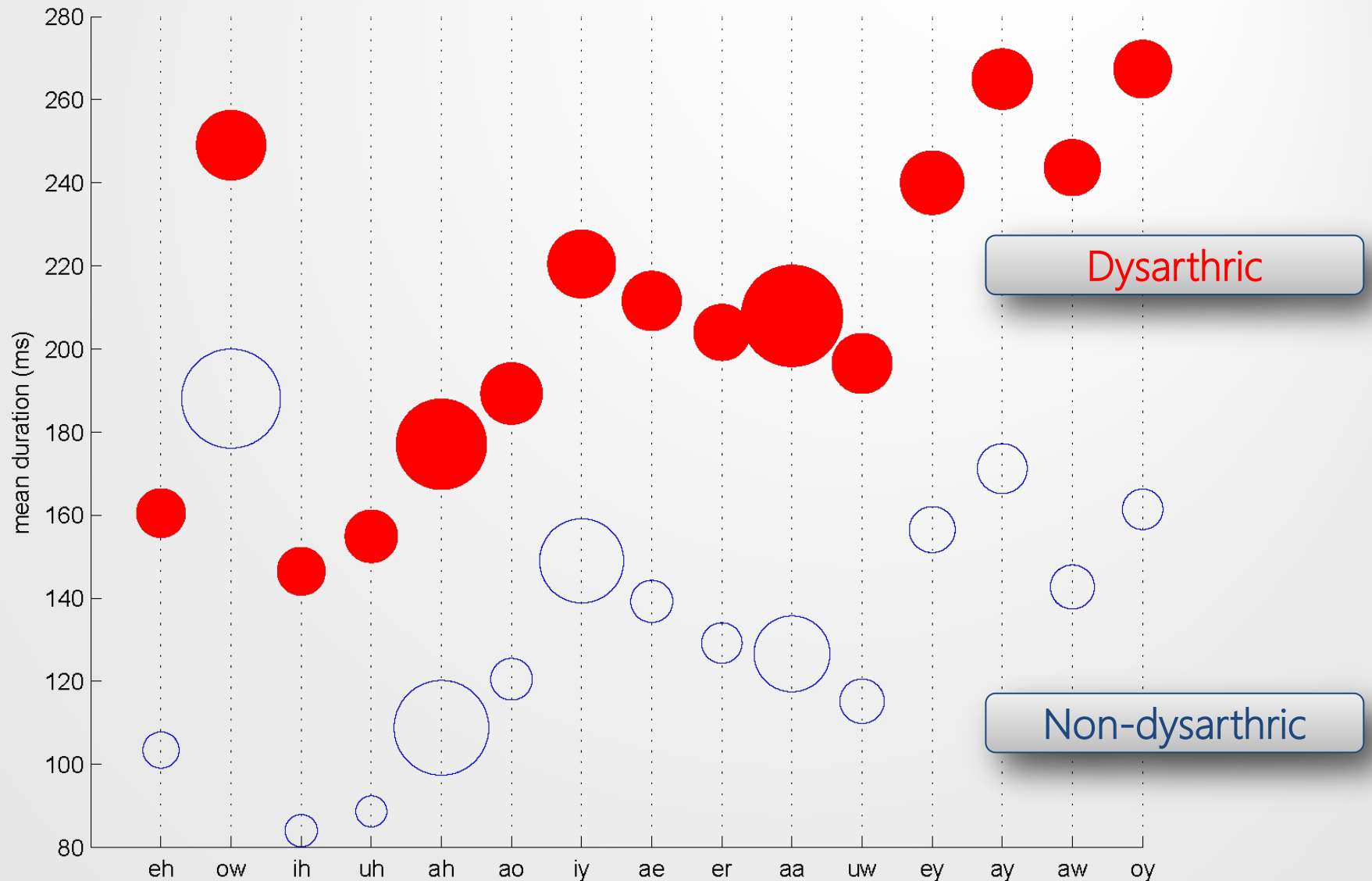

Information in TORGO

	Speaker	$H(Acous)$	$H(Artic)$	$H(Ac Ar)$
Dysarthric	M01	66.37	17.16	50.30
	M04	33.36	11.31	26.25
	F03	42.38	19.33	39.47
	Average	47.34	15.93	38.68
Control	MC01	24.40	21.49	1.14
	MC03	18.63	18.34	3.93
	FC02	16.12	15.97	3.11
	Average	19.72	18.60	2.73

Dysarthric **acoustics** are far more statistically disordered than the control data *but*

Dysarthric **articulation** is *just as* statistically ordered as the control data *yet*

Dysarthric acoustics are far less **predictable** from articulation.

Classifying dysarthric acoustics

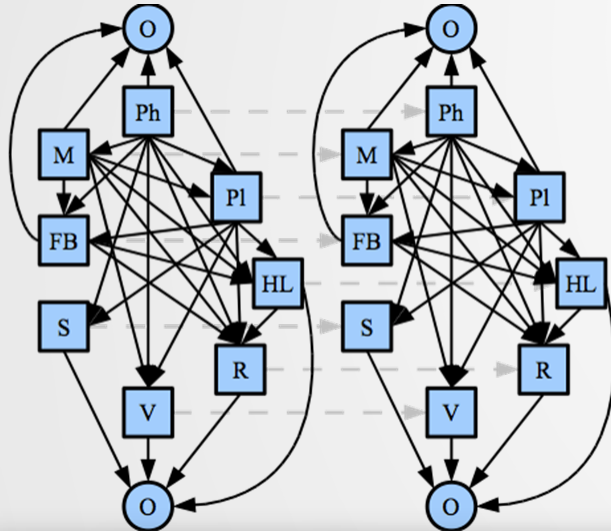

Dynamic Bayes nets
(DBN-F)

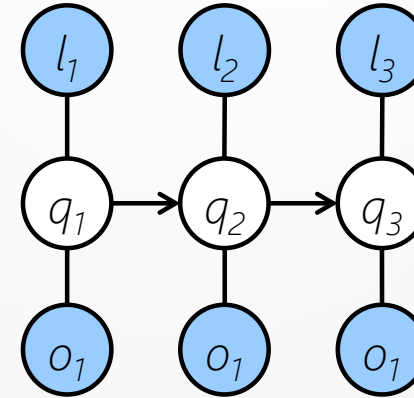

Conditional random fields
(LDCRF)

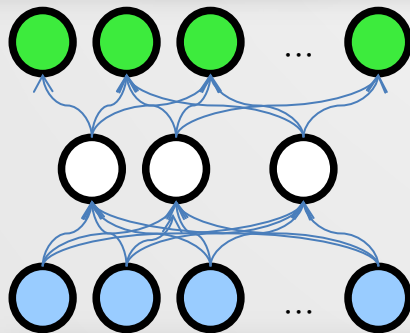

Neural networks

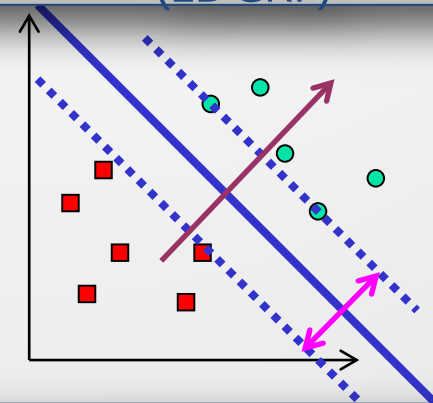

Support vector machines

Dynamic Bayes nets with EMA data

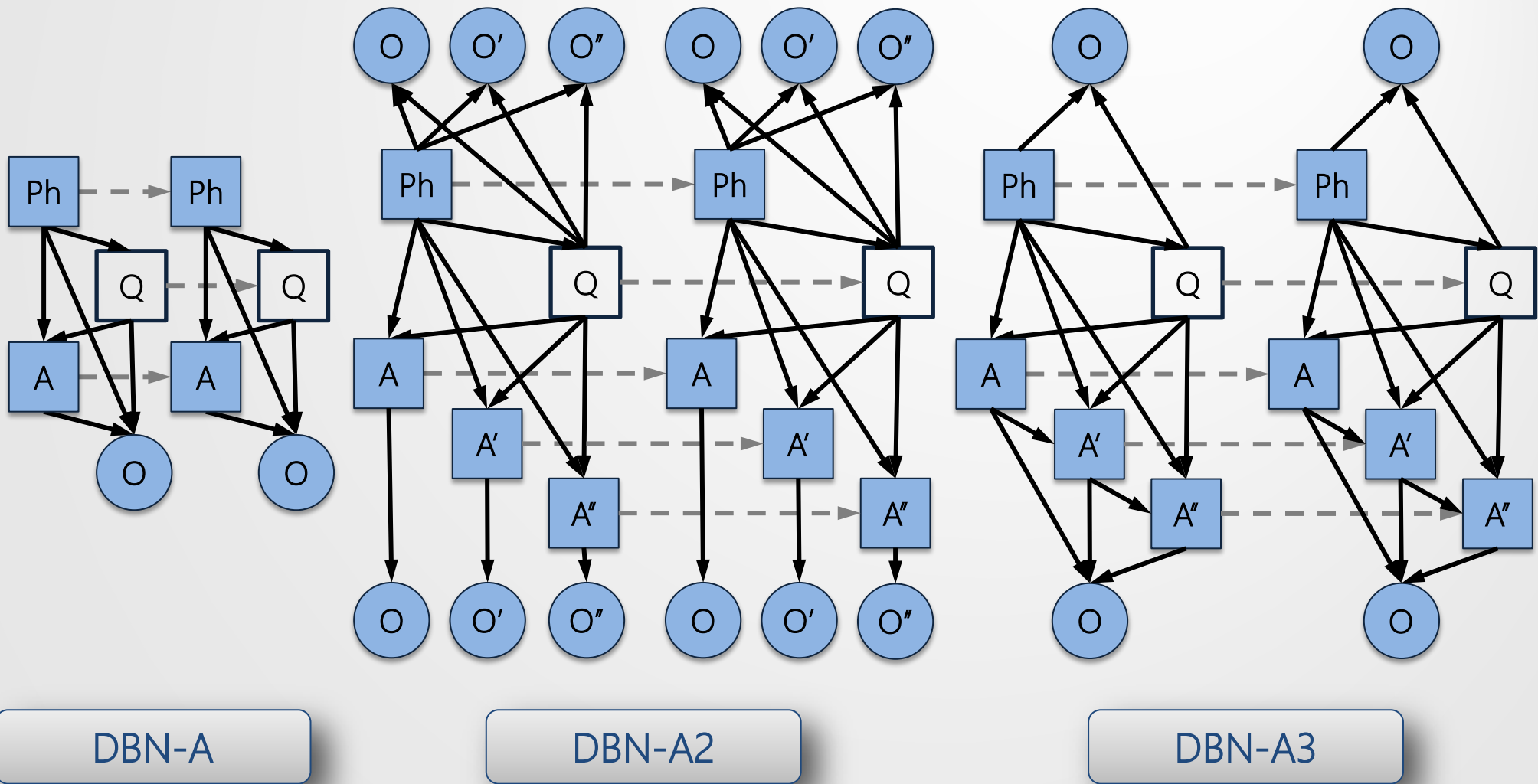

DBN-A

DBN-A2

DBN-A3

Dynamic Bayes nets with EMA data

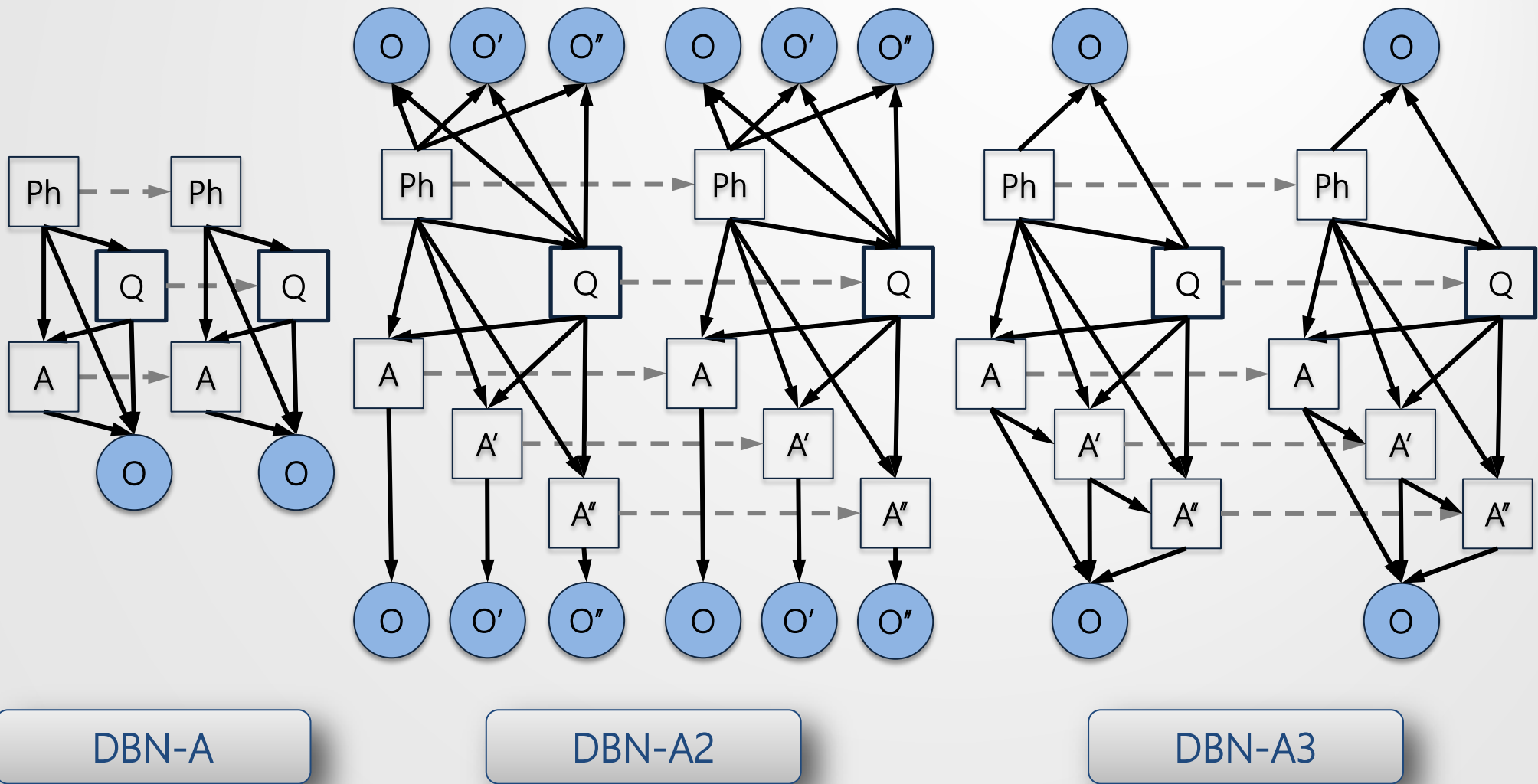

DBN-A

DBN-A2

DBN-A3

Phoneme recognition

Severity of dysarthria	HMM	LDCRF	DBN		NN	
			DBN-F	DBN-A	MLP	Elman
Severe	14.1	15.2	15.0	16.4	15.5	15.6
Moderate	27.8	28.0	28.0	31.1	28.6	30.5
Mild	51.6	51.8	51.6	54.2	51.4	51.2
Control	72.8	73.5	73.3	73.6	72.6	72.7

Average % phoneme accuracy (frame-level) with speaker-dependent training

Beyond discrete articulation

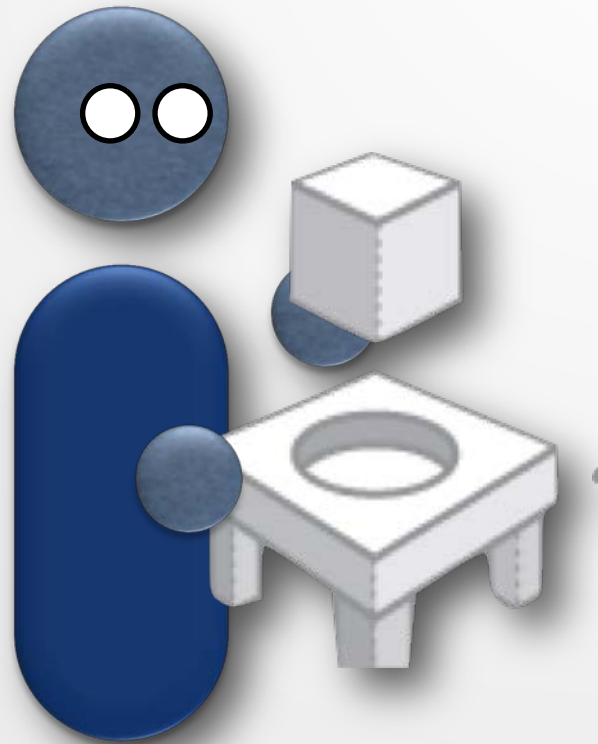

Dynamic speech gestures

We wish to classify dysarthric speech in a low-dimensional and informative space that incorporates **goal-based** and **long-term dynamics**.

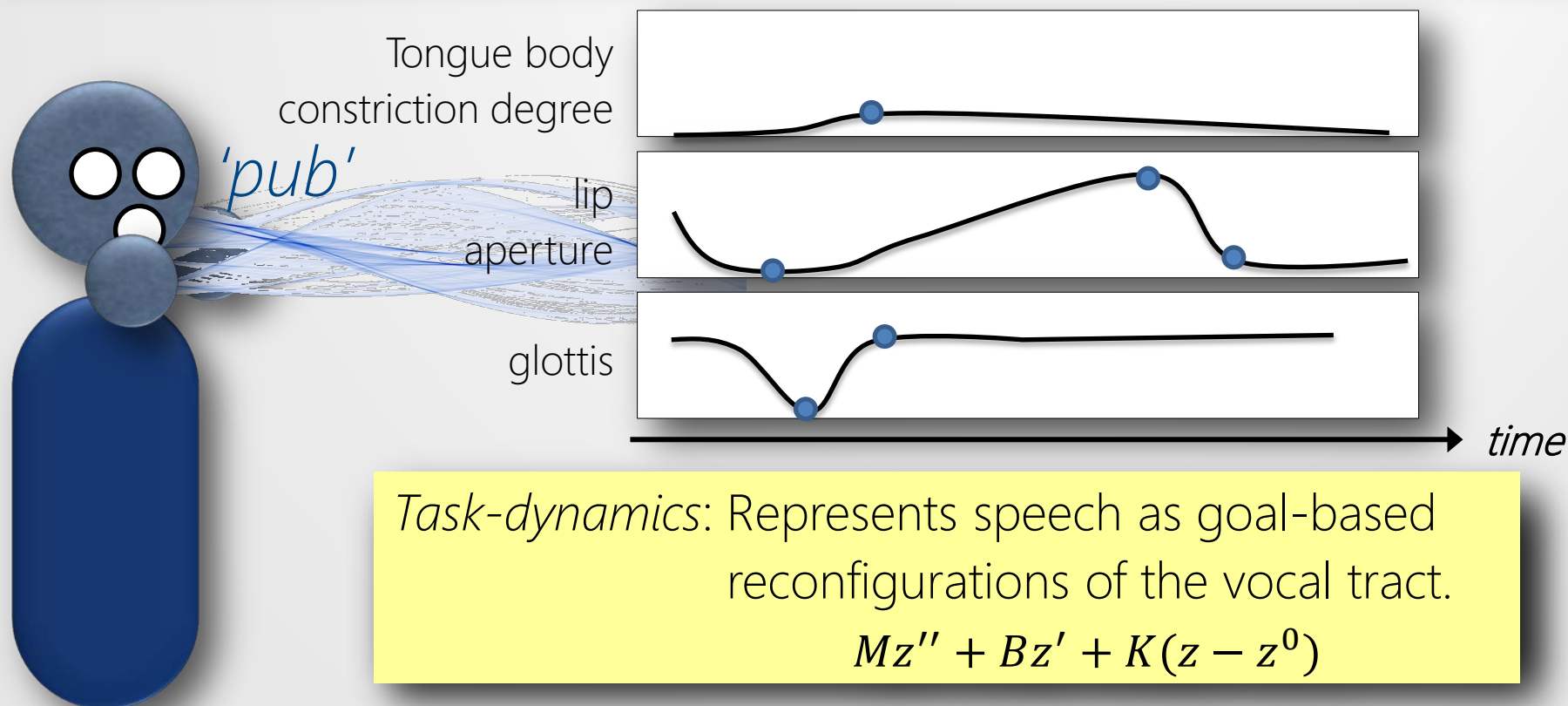

Characteristics of dysarthria

	Ataxic	Flaccid	Hypo-kinetic	Hyper-kinetic, chorea	Hyper-kinetic, dystonia	Spastic	Spastic-flaccid (ALS)
Monopitch	Red	Red	Red	Red	Red	Red	Red
Harshness	Blue	Blue	Blue	Blue	Blue	Blue	Blue
Imprecise consonants	Red	Red	Red	Red	Red	Red	Red
Mono-loud	Red	Red	Red	White	Red	Red	Red
Distorted vowels	Blue	White	White	Blue	Blue	White	Blue
Slow rate	Red	White	White	White	White	Red	Red
Short phrases	White	Red	White	White	White	Red	Red
Hypernasal	White	Blue	White	White	White	Blue	Blue
Prolonged intervals	Red	White	White	Red	White	White	Red
Low pitch	White	White	Blue	White	White	Blue	Blue
Inappropriate silences	White	White	Red	Red	Red	White	White
Variable rate	<p><i>Task-dynamics:</i></p> $Mz'' + Bz' + K(z - z^0)$						
Breathy voice							
Strain-strangled voice							
...							

Aspects to consider

- As we develop an **extension** or **alternative** to task dynamics, we have to consider:
 1. **Timing.**
 - a) Inter-articulator co-ordination.
 - b) Rhythm.
 2. **Feedback.**
 - a) Acoustic, proprioceptive, and tactile.
 3. **Higher-level features**
 - a) Syntax and meaning

1. Timing

- In TD, pairs of goals are dynamically coupled in time.
- Articulators are phase-locked (0° or 180° ; Goldstein *et al.*, 2005)

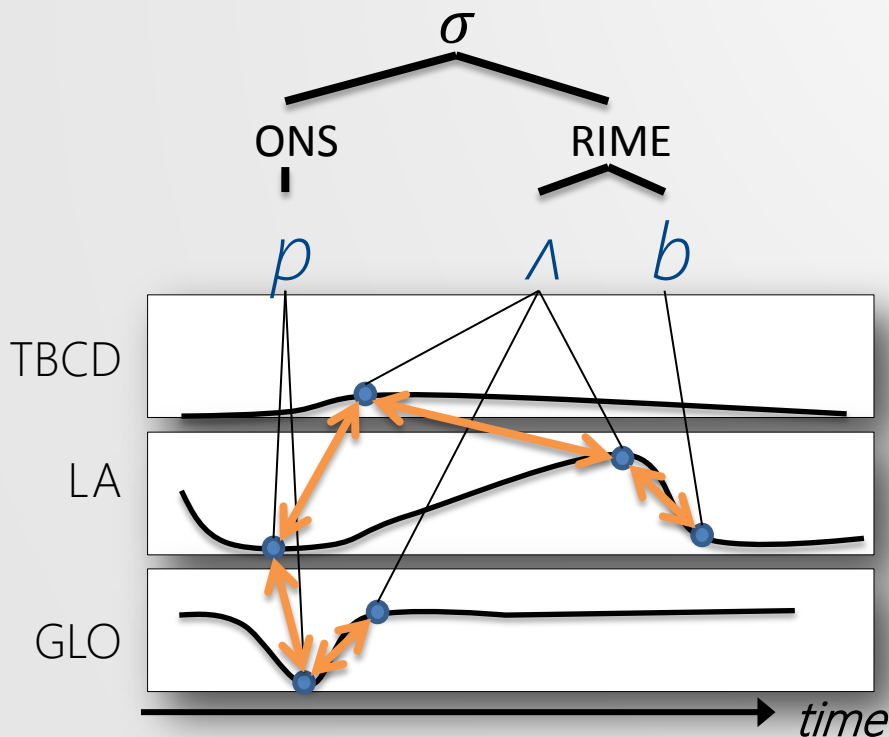
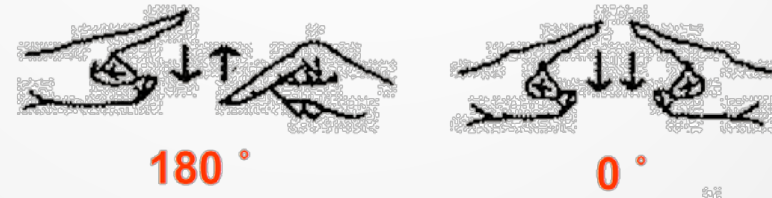

- (C)CV pairs stabilize in-phase.
- V(C)C pairs stabilize anti-phase.
- **Kinematic errors** occur when **competing** gestures are **repeated** and tend to stabilize **incorrectly**.
 - e.g., repeat *koptop* (Nam *et al.*, 2010).

1. Timing

- Cerebellar **ataxia** often **prohibits** control over more than one articulator at a time.
 - **Apraxia** generates incorrect motor **plans**, wholly **distorting** gestural **goals**, hence timing.
- Dysarthric speech **nearly equally** consists of **steady-states** (49.95%) and **transitions** (50.05%) (Vollmer, 1997).
 - **Typical** speech consists of **~82.14%** steady-states.

1. Timing/rhythm

- Rhythm (the distribution of **emphasis**) is *not* part of TD.
- Tremor behaves as oscillations about an equilibrium.
 - There is **evidence** that people with **Parkinson's** coordinate **voluntary** movement with **involuntary** tremors (Kent *et al.*, 2000).
- Rhythm in **ataxic** dysarthria formalized by aberrations in a 'scanning index', **SI**, consisting of syllable lengths S_i ,

$$SI = \frac{\prod_{i=1}^n S_i}{\left(\frac{\sum_{i=1}^n S_i}{n}\right)^n} \quad (\text{Ackermann and Hertrich, 1994})$$

2. Feedback

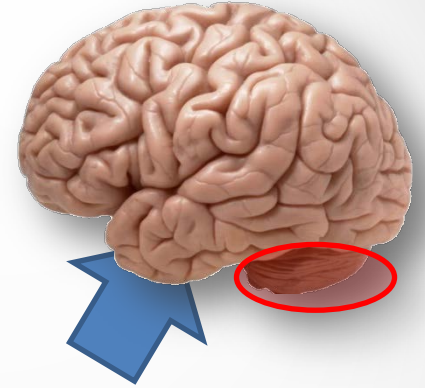

- Dysarthria can affect **sensory** cranial nerves.
- Parkinson's disease reduces **temporal** discrimination in **tactile, auditory, and visual** stimuli.
 - Likely explanation is that **damage** to the **basal ganglia** prohibits the formation of **sensory targets** (Kent *et al.*, 2000).
 - The result is **underestimated** movement.
- Cerebellar disease results in **dysmetria** since the **internal model** of the **skeletomuscular system** is **dysfunctional**.
 - The **cerebellum** is apparently used in the **preparation** and **revision** of **movements**.

2. Feedback and DIVA

- The DIVA model is **supposed** to model feedback, but is largely **speculative** on neurological aspects.
- Here, **sound targets** and **somatosensory targets** are **learned** during 'babbling' and **modify** articulatory goals.

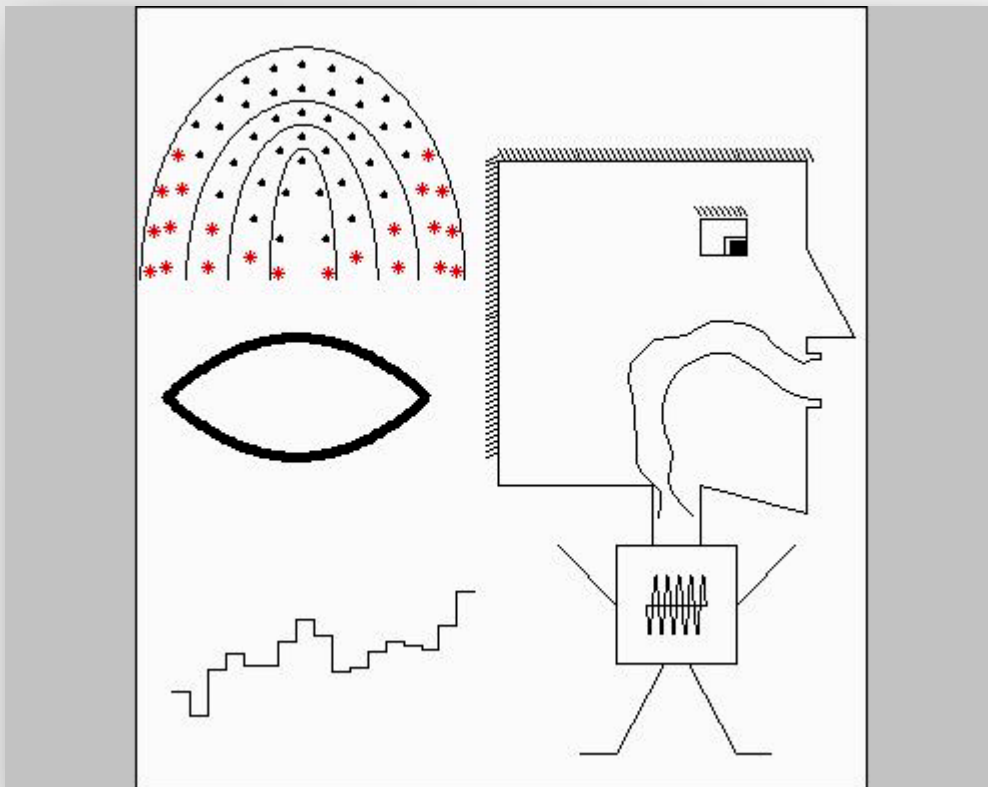

- This is meant to imitate the cerebellum (or basal ganglia).

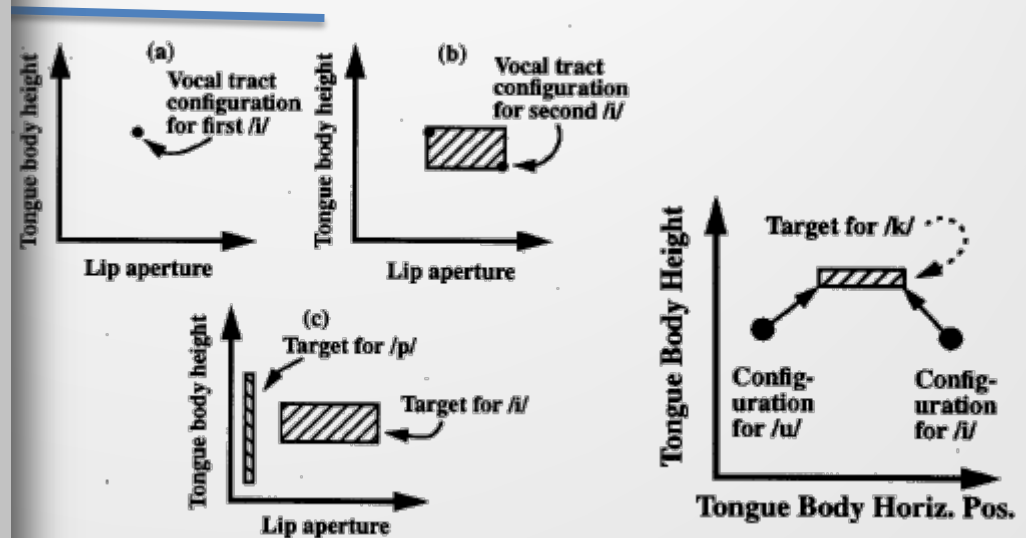

3. Further into the brain with aphasia



Broca's aphasia

- Reduced hierarchical **syntax**.
- Anomia.
- Reduced "mirroring" between observation and **execution** of **gestures** (Rizzolatti & Arbib, 1998).



Wernicke's aphasia

- Normal intonation/rhythm.
- **Meaningless** words.
- 'Jumbled' syntax.
- **Reduced** comprehension.

Summary



Dysarthria is a prevalent disorder that would be mitigated to some extent by **improved speech technology**.

Some **benefit** can be derived by building in **explicit articulatory-acoustic statistics** into simple **acoustic models** for dysarthria.

About **3.3%** improvement in **phoneme error rate** for **moderately** dysarthric given models trained with EMA data.

Dysarthria presents with **complex long-term effects** that are **difficult to capture** in short-time models

Extensions to task-dynamics, e.g., should take into account some of these phenomena.

Thanks!