

Portation

[Eric Hehner](#)

artwork by Ryan Elliott

Introduction

Portation is a system of land transportation. It performs the same function as cars and trucks on roadways, and as trains on railway tracks. It moves people and goods across land, within cities, between cities, and in the countryside. Unlike cars, trucks, and trains, portation does not require dedicated land. It is electrically powered. It is automated, and safe. It has higher capacity than roads and railways. And it is cheaper to build and maintain than roads or railways. Portation is not a futuristic fantasy; all its technology is within our present knowledge.



Portation vehicles are called porters, and most of the time they travel on an unusual kind of elevated track called a portway. But they can also travel on ordinary roadways. Your personal porter can start in your driveway, driving on roads perhaps one or two blocks to the nearest portway, then on portways to perhaps one or two blocks from your destination, then on roads to finish the trip, door-to-door. While you are on the portways, driving is automatic and high-speed, reaching perhaps 400km/h on long stretches, while you read, watch a movie, or sleep. While you are on the road, at the start and finish of the trip, driving is human-controlled, same as a car. A porter for carrying goods may start on one company's spur portway, and finish on another company's spur portway, with no human driver. Porters supplement or replace most, but not all, functions currently performed by cars, trucks, buses, trams, surface trains, and subway trains. They cannot perform the functions currently performed by fire trucks, garbage trucks, heavy construction vehicles, police cars, and ambulances.

Debate about transportation often compares cars with public transit. Cars are a technology; public transit refers to shared ownership and use. It makes no sense to ask whether

a particular technology is better or worse than a particular method of ownership and use. Cars and buses are the same technology; the difference between them is just size. The smaller size cars are more suitable for private ownership, and the larger size buses are more suitable for public ownership. More accurately, cars are just part of the car-plus-road technology, and the larger part of that technology, the roads, are mostly publicly owned. Like cars, porters would most often be privately owned; like roads, portways would most likely be publicly owned. But portation is a different technology, and it's the technology that this essay is about.

Contents

[Introduction](#)

[Contents](#)

[Portway](#)

[Porter](#)

[Power](#)

[Economy](#)

[Building](#)

[Maintenance](#)

[Payment](#)

[Capacity](#)

[Parking](#)

[Entries and Exits](#)

[Opposition](#)

[Personal Rapid Transit](#)

[Direction Control](#)

[Speed Control](#)

[Merge](#)

[Divergence](#)

[General Control](#)

[Three-Second Distance](#)

[On the Street](#)

[Safety](#)

[Intersection Topology](#)

[Specification](#)

[Comparisons](#)

[Cars](#)

[Trains](#)

[Airplanes](#)

[Boats](#)

[Summary](#)

[Disclaimer](#)

[History of the Project](#)

Portway

A portway is an elevated pair of rails. The rails provide electric current to porters. Unlike a railway, the mechanism that keeps the porter on the portway is not a flange on the wheels. Also unlike a railway, the mechanism that controls the direction of the porter at a divergence is not a movable rail. A portway has no moving parts.

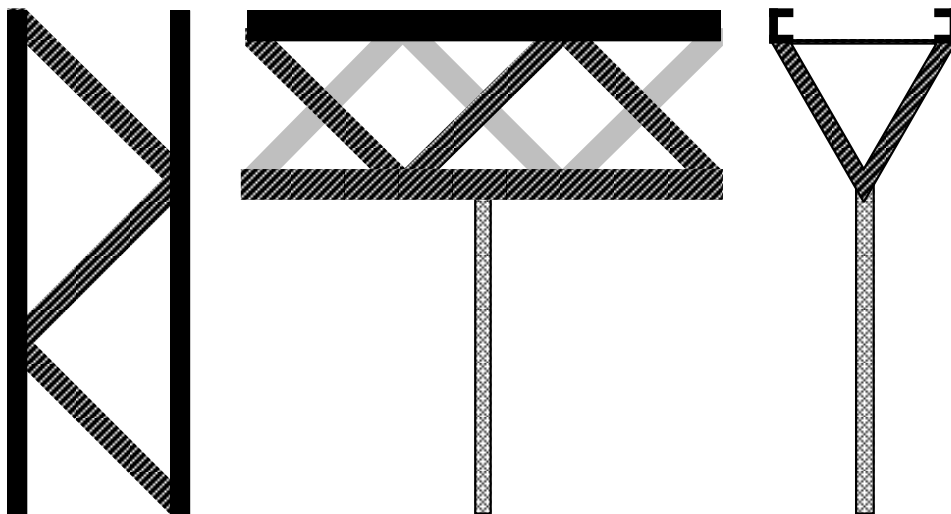

A portway is a pair of rails, each rail 30cm wide, 1.5m apart, connected by triangulated ties. Triangulation gives maximum strength with minimum weight. The rails are elevated to a typical height of 4.5m by pillars spaced typically 10m apart. The height and pillar spacing will vary according to local terrain.

The left diagram on the previous page is a top view; the two rails are solid-shaded, with stripe-shaded ties between. The middle diagram is a side view; the near rail is at the top; the far rail and the ties between the rails are hidden by the near rail; the stripe-shaded struts are beneath the near rail and the faintly-shaded struts are beneath the far rail; the pillar is crosshatch-shaded. The right diagram is a slice view; the rail cross-sections are at the top left and right; each rail is three sides of a rectangle 30cm wide and 60cm tall; we also see a tie between the rails, the support struts for the rails, and a pillar.

The image of a monorail carrying a train is misleading. A portway carries high-speed, densely packed porters, each going its own individual route. The image of an elevated highway for cars and trucks is also misleading by several orders of magnitude. Cars have to be strong and heavy enough that they are not blown sideways, and to provide all possible safety to their occupants in the event of a crash. Trucks have to carry enough goods to pay for the driver, and that makes them heavy. Roadways must be wide enough to allow for the inaccuracy of drivers. The roadway of an elevated highway is so massive that the vehicle weights are insignificant by comparison, and the pillars needed to elevate the roadway are correspondingly massive. In contrast to cars and trucks, porters cannot be blown sideways, and they don't crash, so they don't have to be heavy. Porters carrying goods don't need drivers, and don't need to be large. Porters are constrained by the rails of the portway, so no extra width is needed to allow for inaccurate driving. A portway is slight and slender in comparison to an elevated roadway.

Pillars that support the portway superstructure solidly and safely can certainly be built. But if we want them to be slender, the structure will be weak, particularly where the pillars attach to ground and superstructure. We can have more strength and stability using less material than a solid pillar by using a bundle of four pillars. At the base, the pillars are attached to the corners of a 1m square. Somewhere near halfway up, the pillars are touching each other, and are held together by a ring. At the top, two diagonally opposite pillars are supporting the two rails, and the other two pillars are supporting the spine (below and between the rails) of the superstructure. Pillars should be built so that it is impossible for animals or humans to climb them.

Within a city, adequate coverage requires a portway (one direction only) on maybe a third of the streets. The pillars may be on the center line or on the road edge, depending on the street.

At an intersection, crossing portways are at different heights, with connecting portways for turning traffic. Using different heights means that traffic in one direction never has to wait for traffic in another, nor for pedestrians, and that contributes greatly to the speed and capacity of the system.

Building a portway across the countryside does not require grading or leveling the land. Pillars are taller or shorter as necessary to compensate for land irregularities. Farming can take place underneath a portway, and fields are not split inconveniently. Across wilderness, wildlife is not divided into unsustainably small areas, as happens with highways.

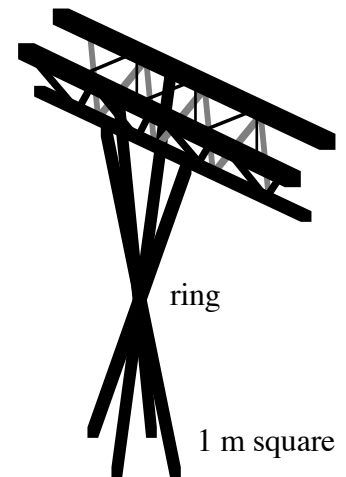



Visual clutter is a serious concern, and portways add to the visual clutter. But portation does not require the visual clutter of signs and lights to control traffic, as cars on roads do. And as noisy cars and trucks are replaced by almost silent portation, noise pollution is reduced.

Many streets have overhead wires that would interfere with portways. These wires can be carried along the portway, removing both the interference and the clutter. Street lighting currently atop lighting poles can instead be on portway pillars, reducing clutter further.

Porter

A porter is a vehicle capable of traveling on either a portway or a roadway. On a portway, its electric motors are powered, and its battery is charged, by electric current provided by the portway. On a road, its electric motors are powered by its battery. Its battery can also be charged by plugging it in when it is parked in a garage, but this should seldom be necessary.

When on a road, a porter is operated the same as an ordinary car. When on a portway, it has three buttons that affect its operation: the “left” button, the “right” button and the “exit” button. Pressing the left button means that the porter will take the next left turn. Pressing the right button means that the porter will take the next right turn. Pressing the exit button means that the porter will take the next exit onto the street. If a button has been pressed and the requested action has not yet been taken, pressing it again undoes the request. If a button has been pressed and the requested action has not yet been taken, pressing another button undoes the request and replaces it with a request for the new action. In addition to these three buttons, there will be a way to program any sequence of actions. And, perhaps in conjunction with a GPS device, there will be ways to specify the desired end location, and the correct sequence of turns will happen automatically.

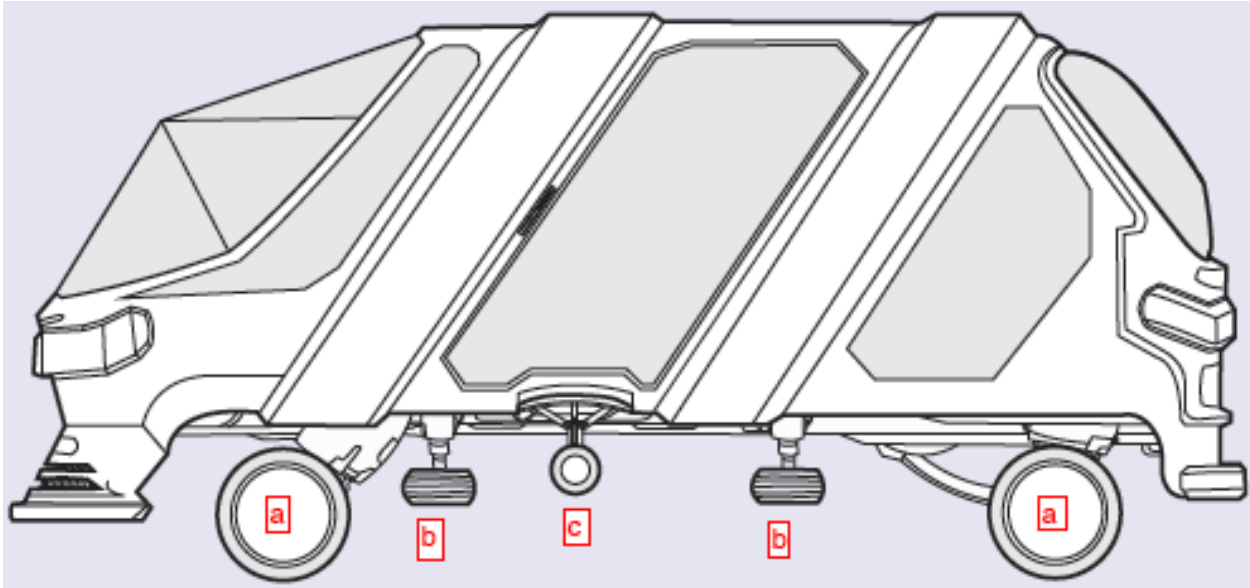

Here is a side view of a porter (front at left). There can be many styles and sizes of porter, serving different needs and tastes. A porter is light, perhaps constructed mainly of plastic. This picture shows the ten wheels of a porter. At its four corners there are wheels (marked “a”) that run on the rails and propel the porter. There are four horizontal wheels, two on each side (marked “b”), that press outward on the rails and guide the direction of the porter. There are two wheels, one on each side (marked “c”), that press upward on the rail when necessary to keep the porter down; this is important at high speed to keep the porter from “taking off”.

Here again is the rail cross section showing where each wheel touches the rail. (The letters “p” show the location of the electric power; see [Power](#).)



This porter's doors (one on each side and one at the rear) open upward. On each side of the side doors there are vertical flange shafts that direct the porter at merges and divergences (see [Direction Control](#)).

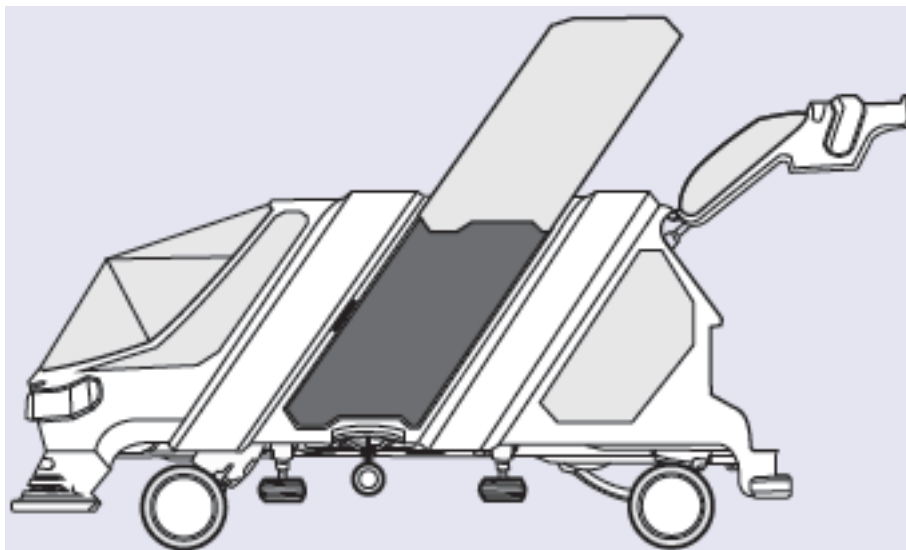

Here is a top view, a front view, and a rear view.

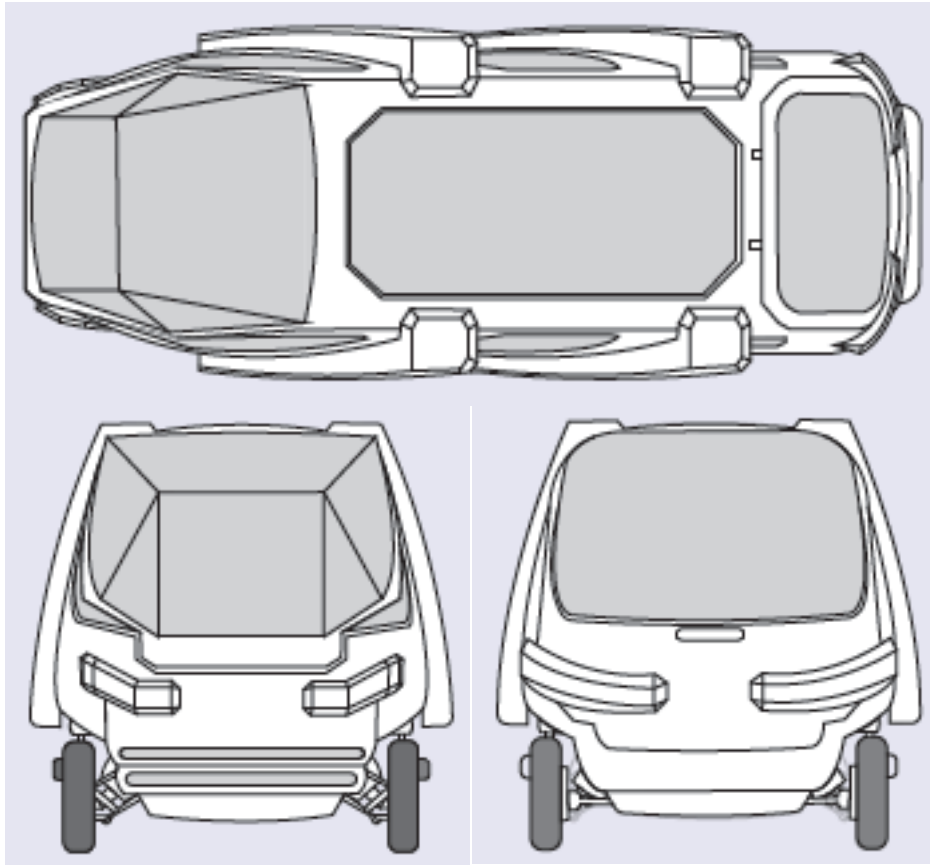

In the interior, six people can sit on swivel chairs; they can each face inward for conversation, or outward to look at scenery.

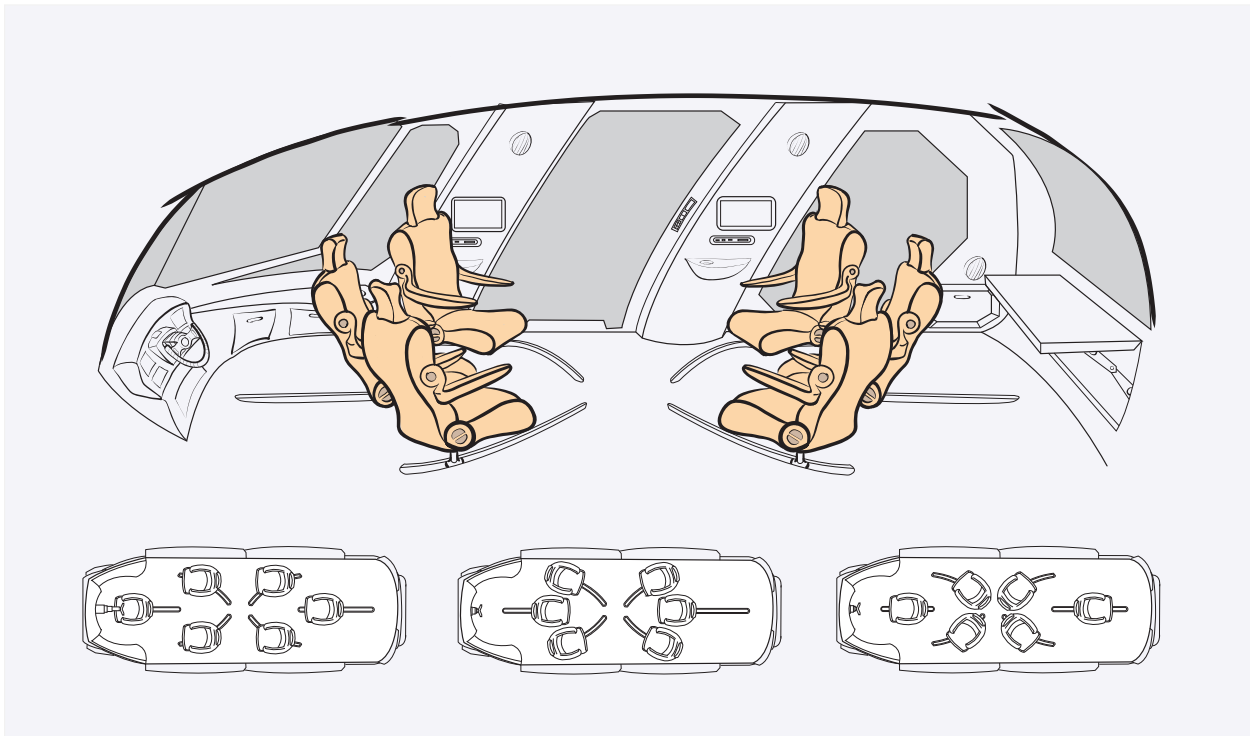

Power

Electric power comes from a pair of cables, one beside each of the lower rail surfaces (marked “p” in the preceding section). A porter has “shoes” to contact the cables in the same way as subway trains. At a merge or divergence, the left and right rails cross each other; there, the two cables are replaced by an insulator that provides a continuous physical pathway for the shoes, while the current-carrying cables hop under that spot, insulated from each other; the electrically dead spot is about 50cm. A porter does not feel the dead spot because it has two shoes on each side, with the front and rear shoes separated by more than 50cm. The shoes retract when the porter is on a street.

Electrically powered vehicles are clean and nonpolluting. But electricity is not an energy source; it is a means of energy transmission; the electricity must be generated somehow. Using electrically powered vehicles does not solve the problems of pollution and oil supply, but it decouples the vehicles from the problems. There are clean and efficient ways to generate electricity, and we should be using them. And as new ways are discovered and put in place, portation takes advantage with no need to convert the motors of the porters.

Hydrogen has often been touted as a clean energy source for vehicles. But hydrogen, like electricity, is not an energy source; it too is a means of energy transmission. Hydrogen (separated from oxygen or other atoms) does not occur naturally on Earth; it is generated from fossil carbohydrates using electric power. And it takes much more energy to generate hydrogen than you get back by burning the hydrogen, so for efficient use of energy, it is better to use the electricity directly, rather than through the medium of hydrogen. When power is transmitted by electric wires, there are transmission losses. When power is transmitted by hydrogen, there are also transmission losses: it takes energy to transport the hydrogen from where it is produced to where it is used. A proper comparison must take this into account. And when it is taken into account, electric wires are the clear winner. If we ever find a means of transmitting energy that is better than electricity, that means should be used for portation in place of electricity.

For powering our current road-based cars, electricity suffers the further conversion (and loss) into chemical form in batteries, which currently have a small capacity for storing energy and a long recharge time. But portation provides electric power all along all portways, so it does not have that problem.

Electric motors are more powerful, have quicker response time, and are more accurately controllable than combustion (gasoline or hydrogen) motors, so they enable denser packing, and therefore higher traffic capacity.

An electric motor is just as good at providing deceleration as it is for providing acceleration. For acceleration, the rotating magnetic field is timed to be ahead of the rotator, driving it faster. For deceleration, the rotating magnetic field is timed to be behind the rotator, slowing it down. An electric motor can provide more acceleration than is comfortable, and more deceleration than a human occupant can stand. And it does so without mechanical friction that wears out mechanical brakes. Mechanical braking converts forward momentum into heat, which is lost. Electrical braking converts forward momentum into electrical energy that charges the battery, and is not lost. (Electric cars currently use electrical braking to supplement mechanical braking for the purpose of saving energy.)

A porter has ordinary rotary electric motors, one for each drive wheel (two or four). Each drive wheel is its motor's rotator. There are no spark plugs, no cylinders, no transmission, no gears, no drive shaft, no cooling system, and no mechanical brakes. There are a battery, some wires, and two or four electric motors/wheels.

A glamorous alternative to the rotary electric motor is the linear electric motor coupled with magnetic levitation (maglev). This alternative significantly increases the expense of building and maintaining portways, and to date is less reliable than old-fashioned wheels and

rotary motor, which are required in any case when porters travel on roadways.

Economy

Building

The cost of building a roadway includes land acquisition, grading the land to limit the slope and eliminate bumps, preparing the roadbed to bear the load, surfacing the road, perhaps adding guardrails and a center divider, painting the lines, and putting up signs. Bridges are especially expensive.

To build a portway, land acquisition costs are almost eliminated. The land under a portway can be used for farming, as a park or playground, or for most other activities, without interference due to noise. Portways can be built over existing roads. When they are built over farms or wilderness, there are no grading costs; pillars are shorter or longer as necessary. Pillars need foundations, but that costs far less than building a roadbed. A portway “bridge” is just a normal portway. There are no guardrails, center divider, lines, or signs.

A portway is not built on site; it is built in a portway factory, and assembled on site. Pillars are stockpiled in several heights and are adjustable between those heights. At any location, the disruption time is not years or months, but days; concrete footings must be laid, then prefabricated pillars and rails are snapped together.

As we build portways, we have less need for building roads, and that saves money.

A full analysis of portway building costs must await more detail, but it seems clear that portway building costs will be much less than road building costs. It may even be true that portway building costs are less than the maintenance costs of an equivalent length of roadway for a small number of years.

Maintenance

Road maintenance costs include annual pavement patching, periodic resurfacing, snow removal, salting, annual line painting, and occasional repairs to guardrails and signs. All too often, immediately after resurfacing, there are utility (pipes, wires) repairs that require digging up the road, then patching it, leaving cracks for water to seep in and freeze and cause further damage.

Portways require maintenance also. The rail surfaces must be maintained, but each rail is only 30cm wide, and made of a more durable material than road surfaces, and not as susceptible to water damage. So surface maintenance will be much cheaper for portways than for roads. Snow removal should be unnecessary; each rail is narrow and the surface where the wheels run is covered by the top part of the rail. If snow accumulates, there are open spaces between the rails, so any passing porter will push off the snow. Where and when icing is a problem, some of the electric power can be used for de-icing. There are no lines to paint, no guardrails and no signs to repair.

Portways decrease road maintenance costs because, with less road traffic, road resurfacing needs to be done less often.

A full analysis of portway maintenance costs must await more detail, but it seems clear that portway maintenance costs will be much less than road maintenance costs. If we include the cost of accidents, both repairs and lives, portation wins by lightyears.

Payment

A porter has a meter to measure the electricity used, which must be paid for just as a homeowner's electricity is metered and paid for. The price can include the electricity used and a

share of building and maintenance costs. Thus portation can be paid for, in part or in total, by its users in proportion to their use.

Capacity

A single intercity portway, at peak loading (6 passengers per porter) and maximum speed (400km/h), can move 400,000 passengers per hour across a point on the portway. A single city portway, at peak loading (6 passengers per porter) and maximum speed (150km/h), can move 225,000 passengers per hour across a point on the portway. For more capacity, more portways can be constructed in parallel. In a city, this is the situation anyway because many streets go in more-or-less the same direction. Between cities, more capacity seems unnecessary, but can be accomplished with express and collector (feeder) portways.

Portways also decrease travel time for ordinary road users by relieving roads of some traffic. They should also decrease air and train traffic within a continent. Portation can take you from New York to Chicago, door-to-door, in 3 hours, and from New York to Los Angeles, door-to-door, in 10 hours, overnight while you sleep.

Parking

A homeowner with a driveway or garage can park a porter just like a car. For apartment buildings and office buildings, a parking structure (underground or above ground garage) can accommodate many porters, just as it does now for cars.

A parking structure for porters can be built entirely with rails: no walls, no floors, no roof. You get out of your porter at the structure entrance, and then your porter finds a free spot and parks itself. Later, at the push of a button, you call your own porter to the exit where you get in. You can even park in one location, and call your porter to come to any other location.

The following diagram shows a portway that splits into a series of parking spots.

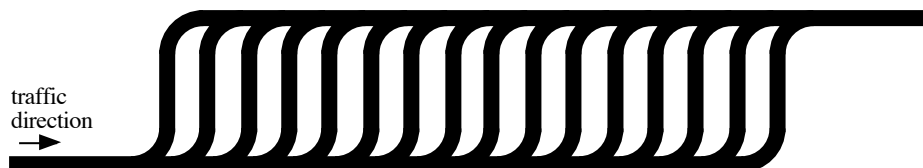

Porters can be parked densely in three dimensions because there's no need to make room for people to park inaccurately and to open vehicle doors and to walk around.

Entries and Exits

An entry ramp to a portway begins at street level; a lane of a street has vertical side guides, 60cm high (the usual portway height) and 3m apart (twice the usual portway width). As the entry ramp rises, the side guides gradually become closer to each other, funneling an entering porter into the proper place. Where the entry ramp becomes the usual portway width, it takes over control of the porter. An exit ramp does not have to become gradually wider, and it relinquishes control at street level. On an entry or exit ramp, a porter is powered by its batteries; for safety, a portway provides electric power only at elevation, not at or near ground level.

A portway is elevated on slender poles, giving it a very small footprint. Adding portation to a community should not be a major disruption. Only the entry ramps and exit ramps require non-negligible space. Community planners will have to decide where entry and exit ramps will be. Perhaps one entry ramp and one exit ramp in any 9 (3x3) block area will be sufficient.

Opposition

Any suggestion for change always meets opposition from those who benefit from the current situation. We may anticipate a host of powerful opponents to portation, including all those who build, maintain, and provide fuel for cars, and all those who plan, build, and maintain roads. Even transportation engineers whose expertise is all about cars and roads may oppose any change that would render their expertise irrelevant. And of course there will be opposition from those who have competing transportation proposals that they wish to sell for their own profit.

In addition to special interest opposition, there will be opposition from a car-loving society. Driving a car can be a pleasure for several reasons. It is a pleasure to be able to go exactly where you want, door-to-door, without changing vehicles, on your own schedule, protected from the weather, singing along to your favorite music, and carrying a load. Portation offers these same advantages. It's also a pleasure to enjoy the scenery along the route; driving a car partially limits this pleasure due to the need to pay attention to the road. Portation allows you to enjoy the scenery fully, or to read, sleep, or watch a movie. For some people, driving a car offers the thrill of controlling a fast and potentially dangerous vehicle. Portation does not have that advantage. If portation becomes the standard, perhaps closed-circuit racing car roads can offer this thrill without endangering those of us who do not choose to be endangered. This last point, that controlling a car is fun, should not be dismissed or underestimated. Cars are sold on the fantasy that you can drive fast, even though the reality is traffic jams and accidents.

There are also a great many serious efforts to improve our current transportation systems. Cars will be made of lighter materials that are as strong as the present materials (making them more subject to lateral winds). Batteries will be improved enough to power a car far enough to be practical (but recharging takes hours). Advances in automated control will make cars driverless (adding to traffic congestion). Each of these improvements will alleviate some problem with car technology, but none of them solves its problem completely, and all of them together leave some of the worst problems untouched. They may, however, create the false impression that, with these and a few more improvements, all problems will be solved, and we don't need a new technology.

Introduction of portation faces yet another impediment: the chicken-and-egg problem. Who will buy a porter when there are no portways for it to run on? And what community will build portways when no-one has a porter to run on them? The problem has occurred before: who will buy a telephone when there is not yet any telephone system, and no other telephone owners? And who will build telephones and a telephone system for nonexistent customers? Radio and television had the same problem. In all cases the problem was solved, and it can be solved for portation too.

Personal Rapid Transit

Personal Rapid Transit, or PRT, refers to several different systems being developed and sold by several companies. These systems are similar to portation in one respect: they use an elevated rail, with electric power. But they differ in other very important respects. One difference is that the vehicles in these PRT systems are confined to the rail. Unlike portation, they are not door-to-door. You have to go to a PRT station and wait there for the next available vehicle (contrary to advertising, there won't always be one immediately available). You have to carry your groceries from the nearest PRT station to your home. In contrast, portation is truly door-to-door, and your porter is always ready for your use.

When you get into a PRT vehicle, it is exactly the way the previous occupants left it moments earlier. After a few uses, it will be dirty and full of garbage. Cleaning these vehicles, and their general upkeep and maintenance, is the responsibility of the system owner (usually a

municipality). If you accidentally leave something valuable in a PRT vehicle, it's gone. In contrast, a portation vehicle is typically owned by its user; its state of cleanliness and repair is its user's responsibility. What you leave in a porter is what you find the next time you use it. Community responsibility is just maintenance of the portways, which are designed for easy maintenance (no moving parts, no fancy technologies, no snow removal except at entry and exit ramps).

Each PRT system is a one-company solution. When a municipality chooses a PRT system, the municipality is captured by the company; only that company can build, maintain, repair, and expand the system (rails and vehicles). The one-company solution prevents competition after capture by means of patents and contracts. The price for a PRT quoted initially by its company may be favorable, but after capture, an escalating price must be paid.

A company that stands to gain a lot can spend a lot on advertising, which makes their system look unrealistically good, and never honestly represents their system's disadvantages and limitations. For example, if the PRT vehicles sit on a solid guideway, do they mention the problem of snow removal? (Portway rails are covered, and they are separated by an open lattice, so there's no snow problem.) What happens when the PRT system power fails? Are all passengers stranded until power is restored? (Porters have batteries allowing them to continue to operate at reduced speed for long enough to exit the system.) Is there a central computer control, which limits system size to a maximum number of vehicles? How many? (Portation has no central control and is not limited in size.)

In contrast to a one-company solution, portation is an open system design; it belongs to no-one. Companies can bid for portway construction, and different companies can build different sections. Portation provides the specifications and standards of construction, just as road construction is done now. Companies can design and build porters and compete to sell them to anyone who will buy; portation provides the specifications and standards so that they will run safely on portways. Portation can always be expanded, piece by piece, to fill a continent, choosing the best contractors for each piece.

Unfortunately for portation, it is probably easier for company officials to wine and dine and convince community officials to buy their shiny complex expensive hardware than it is for technical specification documents to convince them to build a better non-proprietary system.

Readers uninterested in the technical details of direction control and speed control might like to skip ahead to the [Comparisons](#) and [Summary](#).

Direction Control

Small electronic boxes are placed at 1m intervals along portways. These boxes communicate with passing porters by low-power transmission. For direction control, each box has a location indicator, which says one of the following seven things about its location on a portway:

- normal (not approaching a merge or turn or exit)
- on the left branch approaching a merge
- on the right branch approaching a merge
- approaching a left turn
- approaching a right turn
- approaching a left exit
- approaching a right exit

A “merge” means two portways joining to become one. When one portway splits to become two, one of the resulting portways is called a “turn”, and the other is called “straight”. It is a matter to be decided which branch is the turn, and which is straight; it is not determined by the curvature of the portways. A passenger (or program) can choose which branch of each

divergence to follow. “Straight” just means the default branch when the passenger (or program) does not choose. An “exit” means a turn that goes to the ground, off the portway.

To achieve the goals of high speed, dense packing, and inexpensive maintenance, a portway cannot have any moving parts. Instead, a porter has four movable flanges, two on each side. A flange is a vertical rod running the height of the porter, inside a shaft that is part of the frame. Each flange has two positions: retracted (up) and extended (down); a solenoid moves the rod up or down as needed. On each side of the porter, the two flanges work together: both extended, or both retracted. At its lower end, each flange has in it a horizontal wheel to hug the outside of a rail. Here is a picture of a porter on a portway with its left flanges extended.

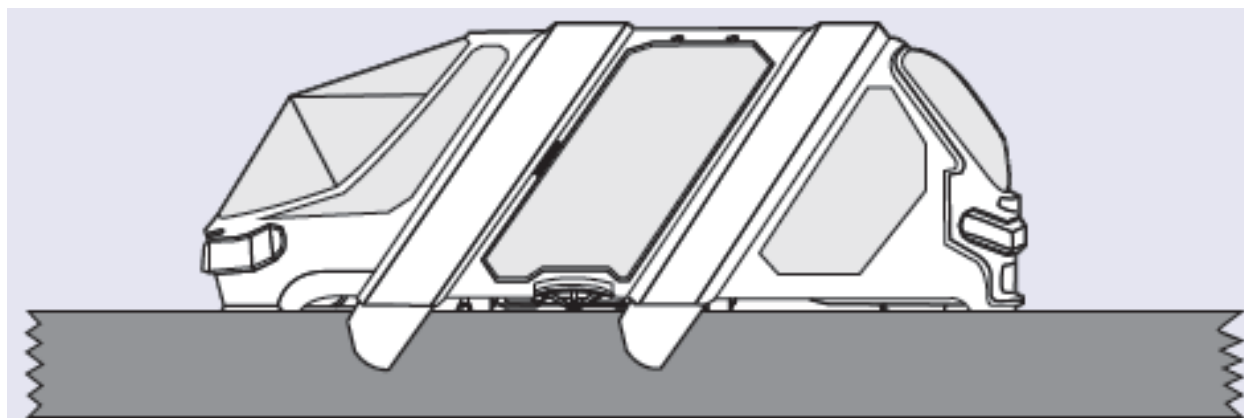

When a passenger presses a turn or exit button (or route preprogramming does the equivalent), there is no immediate change in flange positions. The flanges are controlled by a combination of portway signals and porter button states. Because a porter may be moving at high speed, the flange movements do not have to be precisely timed. Portway signals indicate “approaching” for long enough before a merge or turn or exit to allow the flanges to get into position in time for the merge or turn or exit. Allowing a generous 3 seconds for flange movement, that distance is 33m if the local maximum speed is 40km/h, and 333m if the local maximum speed is 400km/h. This 3s distance places a limit on how close together merges and turns and exits can be. (Two regions each indicating “approaching a left turn” must be separated by at least one box indicating something else. Likewise for right turns, left exits, and right exits.)

All flanges are in their retracted position when the portway indicates “normal (not approaching a merge or turn or exit)”. The left flanges are in their extended position (as in the picture) and the right flanges are in their retracted position in each of the following 5 situations:

- the portway indicates “approaching a right turn” and the right turn button was not in the “pressed” state when the porter entered this region of the portway
- the portway indicates “approaching a right exit” and the exit button was not in the “pressed” state when the porter entered this region of the portway
- the portway indicates “approaching a left turn” and the left turn button was in the “pressed” state when the porter entered this region of the portway
- the portway indicates “approaching a left exit” and the exit button was in the “pressed” state when the porter entered this region of the portway
- the portway indicates “on the left branch approaching a merge”

Symmetrically, the right flanges are in their extended position and the left flanges are in their retracted position in each of the following 5 situations:

- the portway indicates “approaching a left turn” and the left turn button was not in the “pressed” state when the porter entered this region of the portway
- the portway indicates “approaching a left exit” and the exit button was not in the “pressed” state when the porter entered this region of the portway

- the portway indicates “approaching a right turn” and the right turn button was in the “pressed” state when the porter entered this region of the portway
- the portway indicates “approaching a right exit” and the exit button was in the “pressed” state when the porter entered this region of the portway
- the portway indicates “on the right branch approaching a merge”

There is never a time when all flanges are in their extended position.

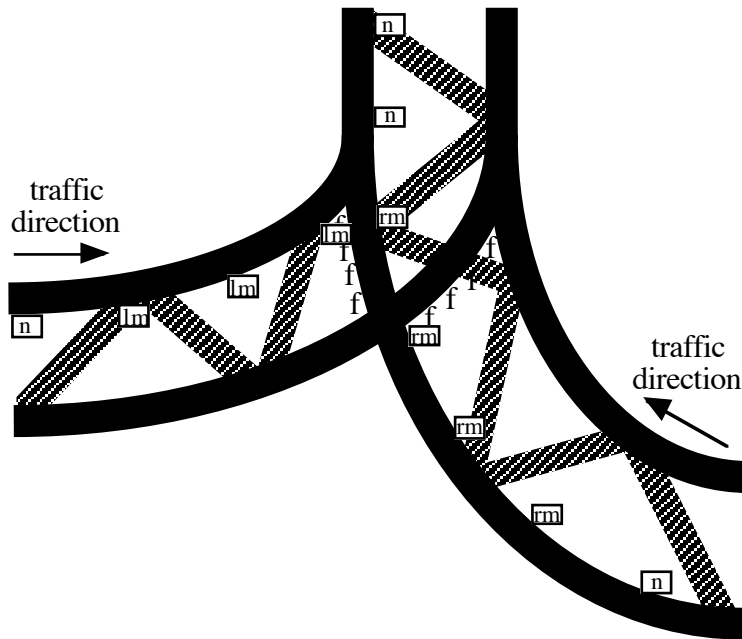

Here is a picture of two portways merging into one portway. The boxes with control information are placed along the inside of the left rails. The letter “n” occurs where the portway indicates “normal (not approaching a merge or turn or exit)”; all porter flanges are in their retracted position. The letters “lm” occur where the portway indicates “on the left branch approaching a

merge”; the left flanges are in their extended position and the right flanges are in their retracted position. The letters “rm” occur where the portway indicates “on the right branch approaching a merge”; the right flanges are in their extended position and the left flanges are in their retracted position. Although the diagram shows only 3 or 4 of the “lm” and “rm” boxes approaching the merge, they should cover the 3s distance (the distance traveled in 3s at the speed limit) to allow the flanges time to extend. Where the letter “f” occurs, the vertical and top parts of the rail are missing; only the bottom part remains (the rail is flat). The absence of the top part of the rail at this place is not a problem because the turning porter will experience a rotation force that keeps that side of the porter down on the rail; on the other side, where the rotation force is up, the rail has its top part to keep that side of the porter down too. The absence of the vertical part of the rail is not a problem because on the other side of the porter the flanges are extended and they guide the porter around the curve.

The diagram shows the left branch of the merge curving to the left, and the right branch curving to the right. It could happen that one of the branches is straight; that is not a problem. It could also happen that both branches curve the same way; in that case the less curving branch must have a slow enough speed (see [Speed Control](#)), or be banked enough, so that there is no problem with porter rotation.

On the next page is a picture of a right turn. As before, the letter “n” occurs where the portway indicates “normal (not approaching a merge or turn or exit)”; all porter flanges are in their retracted position. The letters “rt” occur where the portway indicates “approaching a right turn”. They should cover the 3s distance rather than the 7 shown. If the desire to turn right has been expressed (either by pressing the “right turn” button or by a program) before the porter enters the “rt” region, then, at the moment it enters the “rt” region its right flanges begin to

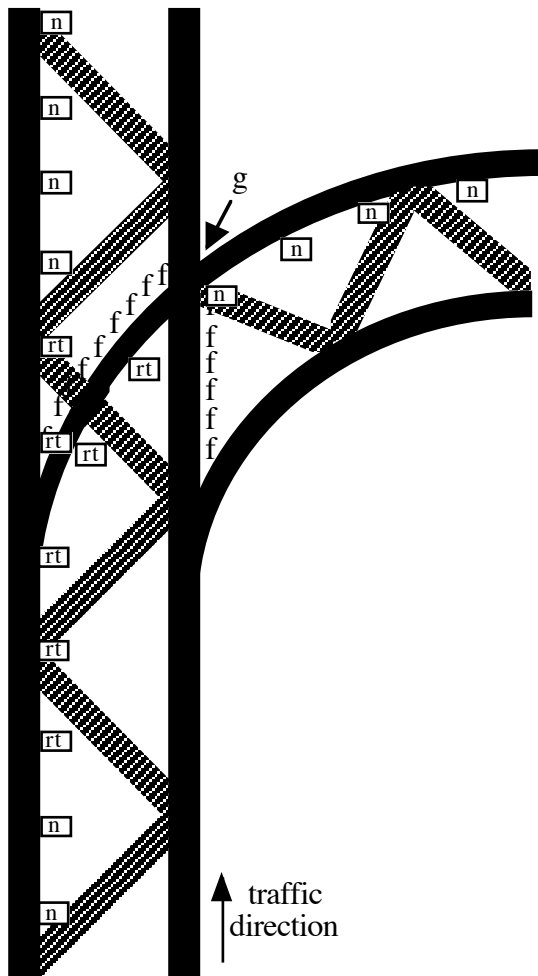

extend; the flanges complete their extension before the porter reaches the point of divergence. If the desire to turn right has not been expressed (or has been rescinded) before the porter enters the “rt” region, then, at the moment it enters the “rt” region its left flanges begin to extend. The extended flanges guide the porter through the region where the letter “f” occurs; in that region the vertical and top parts of the rail are missing, and only the bottom part remains. The top parts of the rail resume at the point marked “g”; that point is slightly recessed so that the horizontal distance between the vertical guides is wider than normal, gently returning to normal. There is a symmetric picture for left turns.

The picture shows the “straight through” section of the portway being straight, and the “right turn” section curving to the right. It could happen that both sections curve in opposite directions; that is not a problem. Or it could happen that both branches curve in the same direction; in that case the less curving branch must have a slow enough speed (see [Speed Control](#)), or be banked enough, so that there is no problem with porter rotation.

When the front of a porter passes over the first box following a merge or turn or exit, the box says “normal (not approaching a merge or turn or exit)”, telling the porter to retract its flanges. The porter knows its speed and length, and waits the appropriate time to ensure that its back flange has passed the region marked “f” before retracting.

On the street, direction control is a normal steering wheel.

Speed Control

A central control would require an enormous number of communications, be subject to communication delays and uncertainties, and place a serious limit on the size of transportation system possible. Portation has no central control. The boxes placed along the portway, which we have already mentioned for direction control, are also used for speed control. A box measures the speed of a porter just when the porter passes over the box, and tells the porter what speed it should be going. If the porter should be going faster, it accelerates, and if it should be going slower, it decelerates. The amount of acceleration or deceleration depends on the difference between the speed it is going and the speed it should be going. A small difference results in a small acceleration or deceleration both for comfort and to damp out density waves. The maximum acceleration may differ from porter to porter; it may be set by the porter's owner to an amount that is comfortable for that owner, or it may be limited by the porter's motors.

There is a maximum deceleration that is the same for all porters. That maximum deceleration should be small enough to be comfortable. And it must be the same for all porters in order to achieve high density: each porter relies on the fact that the porters ahead will not decelerate too quickly. Perhaps 1.7m/s^2 is a nice maximum deceleration.

Each box communicates with passing porters, and also with its neighboring boxes on the portway. A box continuously receives a square speed s^2 from the box in front of it. It adds $2mx$ where m is the maximum allowed deceleration, and x is the distance to the box ahead, and passes the updated square speed $s^2 + 2mx$ to the box behind. The amount $2mx$ may vary a little from box to box (because x may vary), but for each box it is a constant; it is not recalculated. When a porter passes over a box, the box reports to the porter the square speed it is receiving from the box in front. It also measures the speed v of the porter overhead, and sends the square speed v^2 (instead of $s^2 + 2mx$) to the box behind. Thus if there are two porters a distance d apart, with no porters between them, and the porter in front is traveling at speed v , the porter behind receives the square speed $v^2 + 2md$. From this, the porter behind calculates the speed it should be going as $(v^2 + 2md + m^2c^2)^{1/2} - mc$ where c is the porter's cushion time. Cushion time has two purposes: it must be greater than the reaction time of a porter's braking mechanism; and it allows decelerations to be less than the maximum, both for comfort and for damping. The quantities mc and m^2c^2 may vary a little from porter to porter (because c may vary), but for each porter they are constants; they are not recalculated. The speed a porter should be going is such that, by failing to react for the cushion time, and then decelerating at the maximum allowed deceleration, this porter won't hit the one in front even if the one in front decelerates at the maximum allowed deceleration.

Boxes occur at about 1m intervals, and porters are longer than 1m, so a porter is always over at least one box. Almost all porters are always over more than one box. When a box detects the leading edge of a porter, the box sends a 1-bit message to the box behind saying "I am the front box under a porter", and starts sending a square speed to the porter. When a box receives that message from the box ahead, it stops sending a square speed to the porter, and flips the message it sends to the box behind it to say "I am not the front box under a porter". By this means, only the front box under a porter tells the porter a square speed from which the porter calculates what speed it should be going. As long as a porter is passing over a box, the box passes back the square speed of the porter, rather than the updated square speed received from the box ahead.

A box contains a speed limit whose purpose is to limit the speed of porters according to local portway capability. The speed limit varies from box to box according to the curvature ahead on the portway, but for each box it is a constant. Amending the formula in a previous paragraph, a box continuously sends the square speed $\min(s^2 + 2mx, v^2, M^2)$ to the box behind, where s^2 is the square speed received from the box in front, m is the maximum allowed deceleration, x is the distance to the box in front, v is the measured speed of a porter passing over the box, and M is the speed limit. (The square speed v^2 of a porter passing over a box should be less than the square speed $s^2 + 2mx$ updated from the box in front, but for safety, both are included when calculating the minimum.) When no porter is passing over the box, the box uses M in place of v , or in other words, it sends $\min(s^2 + 2mx, M^2)$ to the box behind.

Merge

For the purpose of this description, call the first box after a merge "box 0". Just before the merge, call the box on the portway feeding in from the left "box 1L", and on the portway feeding in from the right "box 1R". Call the boxes just before

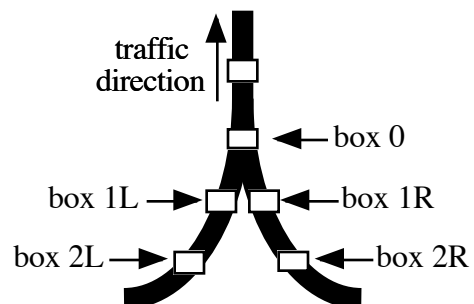

them “box 2L” and “box 2R”, and so on back for the 3s distance.

A merge works as follows. Both boxes 1L and 1R receive and update the square speed passed back by box 0. In turn, these boxes pass back a square speed, as usual. When a porter passes over a box on the left branch leading to the merge, the box measures the porter's speed and passes back its square, as usual. In addition to that, when a porter passes over box nL on the left branch ($n = 1, 2, \dots$), box nL sends the porter's square speed to the corresponding box nR on the right branch. Box nR passes back the smaller of the two square speeds, just as if the porter were passing over it. Symmetrically, when a porter passes over box nR on the right branch, box nR sends the porter's square speed to box nL on the left branch. Thus whenever a porter travels along a portway approaching a merge, a ghostly twin travels along the other portway approaching the merge, causing any porter behind the ghostly twin to reduce its speed, so that at the merge, when the ghostly twin becomes real, traffic merges smoothly.

When a ghostly twin suddenly appears in front of a porter, the porter will begin to slow down to accommodate the ghostly twin. However, depending on the positions and speeds of the porter and the ghost, the porter may overtake the ghost. When this happens, the porter stops seeing the ghost, and resumes its former speed. At the same time, it becomes a ghost to the other porter, which then must make accommodation. Thus porters on the left and right portways can switch their order. But each pair can switch at most once because after the switch the porter in front is going faster than the porter behind.

If, at some moment, a porter traveling at speed v is passing over box nL and no porter is passing over box nR , then both boxes use speed v (in the formula $\min(s^2 + 2mx, v^2, M^2)$) to update the square speed passed to the box behind. Symmetrically, if, at some moment, a porter traveling at speed w is passing over box nR and no porter is passing over box nL , then both boxes use speed w to update the square speed passed to the box behind. If, at some moment, a porter traveling at speed v is passing over box nL and a porter traveling at speed w is passing over box nR , then both boxes use $\min(v, w)$ to update the square speed passed to the box behind. If these two speeds differ, the square speed reported to the faster porter is the updated square speed received from the box ahead, as usual, but the square speed reported to the slower porter is the minimum of the updated square speed received from the box ahead and the square speed received from the corresponding box on the other branch. If these two speeds are equal, the square speed reported to the left porter is the updated square speed received from the box ahead, as usual, but the square speed reported to the right porter is the minimum of the updated square speed received from the box ahead and the square speed of the two porters. In other words, if the two speeds are equal, the left porter is treated as though it were faster, and the right porter as though it were slower. This asymmetry breaks the tie that occurs when two porters, one on each branch, travel toward the merge at the same speed and distance from it; the right porter sees a ghost of the left porter, but the left porter does not see a ghost of the right porter. This gives priority to the left porter.

Divergence

A divergence is a left or right turn or exit. For the purpose of this description, call the last box before a divergence “box 0”. Just after the divergence, call the box on the portway going left “box 1L”, and on the portway going right “box 1R”. Call the boxes just after them “box 2L” and “box 2R”, and so on. Going back from box 0, call them “box -1”, “box -2”, and so on.

A divergence can be implemented simply as follows. Instead of receiving a square speed

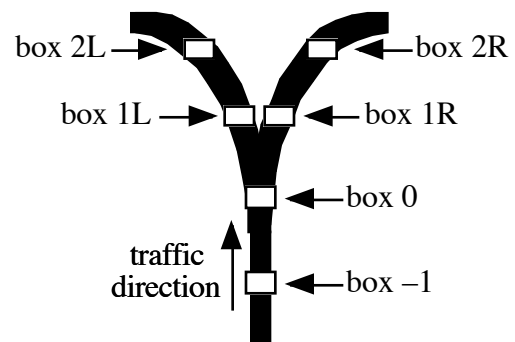

from the box ahead, box 0 receives a square speed from both boxes 1L and 1R, updates each, and takes the minimum of the two. This simple scheme is safe, but not as efficient nor as smooth as possible. Suppose the left side of a divergence is straight through at high speed, and the right side of the divergence is a tight curve, or is an exit to the street, or just has a slowly moving porter on it. This simple scheme slows porters coming up to the divergence, just in case they may be turning right, even if they are going straight through. So, for the sake of efficiency and smoothness, a more complicated scheme is used.

Boxes 0, -1, -2, and so on back for the 3s distance, have two speed limits built into them. Speed limit M_L is for porters taking the left side of the divergence, and M_R is for porters taking the right side. Box 0 receives a square speed from both boxes 1L and 1R. It updates each of them, using M_L for the square speed received from box 1L, and M_R for the square speed received from box 1R. It passes both new square speeds back to box -1. Likewise box -1 updates and passes back both square speeds to box -2, and so on back to the start of the region. When a porter passes over a box in this region, the box reports both square speeds to the porter. The porter uses the appropriate one, determined by its button states at the commit point entering the region.

A slow or stopped porter situated just after a divergence, say over box 1L on the left branch, does not prevent a faster porter from traveling along the right branch, past box 1R. But porters have width, and their widths may occupy an overlapping space. To prevent a crash just after divergence, the solution is as follows. When box 1L detects a passing porter and measures its speed, it sends this speed to box 1R, which also uses it to update the square speed it passes back. Similarly when box 1R detects a passing porter and measures its speed, it sends this speed to box 1L, which also uses it to update the square speed it passes back. Likewise boxes 2L and 2R tell each other about a passing porter. And so on forward until past the danger zone, which may be 4 to 10 boxes, depending on portway curvature. As happens at a merge, a porter on one branch is accompanied by a ghost porter on the other branch, preventing collision.

General Control

Boxes for straightaways, merges, and divergences have been described. It is possible to make a single type of box that can be used in all cases. When installed in its own particular location, 9 parameters must be assigned:

- the location indicator l (one of 7 values)
- the distance x to the box ahead (typically about 1m); at a divergence, use the distance to the nearer box ahead
- the speed limits M_L and M_R ; when there is no divergence soon ahead, these are the same (typically 40km/h to 400km/h)
- two identities of boxes ahead from which it receives square speed information; if there is only one such box (everywhere except at a divergence), these identities are the same
- the identity of a box from which it receives a ghost porter speed (approaching a merge or immediately after a divergence), or its own identity meaning there is no such box
- two more box identities for safety reasons (see [Safety](#))

Each box also has the constant m (perhaps 1.7m/s^2), the system-wide maximum deceleration. It calculates $2mx$ and the squares of the speed limits once, initially, ready for further computation. Each box also includes bit variable b , whose value is 1 when this box is the front box under a porter, and 0 otherwise.

Here is the function of a box on the left branch leading to a merge. Its inputs are as follows. From overhead, it senses:

- bit p whose value is 1 when there is a porter overhead, and 0 otherwise
- square speed v^2 of the porter overhead just while $p=1$

From the box ahead, it receives:

- bit a whose value is 1 when the box ahead is the front box under a porter, and 0 otherwise
- square speed s^2

From the corresponding box on the right branch, it receives:

- bit q whose value is 1 when there is a porter over the corresponding box, and 0 otherwise
- square speed w^2 of the porter over the corresponding box just while $q=1$

Internally, bit b flips from 0 to 1 when p flips from 0 to 1, and bit b flips from 1 to 0 when a flips from 0 to 1. These two flipping conditions are mutually exclusive because the length of a porter is greater than x .

The outputs are as follows. Leading to a merge, $M_L = M_R$, so call it M ; To overhead, it sends:

- location indicator l just while $b=1$
- square speed $\min(s^2 + 2mx, \text{ if } q=1 \text{ and } v^2 < w^2 \text{ then } w^2 \text{ else } M^2 \text{ fi}, M^2)$ just while $b=1$

To the box behind, it sends:

- bit b
- square speed $\min(s^2 + 2mx, \text{ if } p=1 \text{ then } v^2 \text{ else } M^2 \text{ fi}, \text{ if } q=1 \text{ then } w^2 \text{ else } M^2 \text{ fi}, M^2)$

To the corresponding box on the right branch, it sends:

- bit p
- square speed v^2 just while $p=1$

A box on the right branch leading to a merge is identical except that $<$ is replaced by \leq . Boxes in other locations function more simply.

Three-Second Distance

The 3s distance (33m at 40km/h, 333m at 400km/h) has been used for three distinct purposes.

- Three seconds is a safe time for the extension and retraction of flanges. For this purpose, boxes must say “approaching” for the 3s distance leading to a merge or divergence. Merges and divergences must be separated by at least this distance.
- Three seconds is the minimum time for a human to press a direction control button, so for this purpose, divergences must be separated by the 3s distance.
- Three seconds is the time needed for porters approaching a merge to drop back enough to accommodate merging porters. At a deceleration of 1.7m/s^2 for 3s, a porter drops back 7.7m. So porters must have ghosts for the 3s distance.

There is no reason these three distinct purposes should all require the same time and distance; they do by coincidence.

The third purpose by itself, merging, does not place any limitation on how close merges can be. The ghost scheme can easily be generalized to accommodate any number of merging branches within the 3s distance. Each porter on a merging branch has a ghost on all other merging branches. This more general merging scheme is not described in detail because the first purpose, flange movement, requires merges to be separated by the 3s distance. Furthermore, placing merges too close together creates bottlenecks.

On the Street

On the street, speed control is a single pedal. The pedal is a partial shoe, so the front half of a foot fits into it. It has a neutral position that maintains the current speed. In this position, the pedal's upward pressure just balances the weight of the foot, so the foot is relaxed, with no effort required to stay in that position. In that position, the car automatically increases the power to the wheels when necessary, and decreases the power or brakes when necessary, in order to maintain

the speed.

To increase the speed, press your foot down. Press it more for more acceleration, and less for less acceleration. As you approach the desired faster speed, return your foot to the neutral position, arriving there when you reach the desired speed. To decrease the speed, raise your foot. Raise it more for more deceleration, and less for less. As you approach the desired slower speed, return your foot to the neutral position, arriving there when you reach the desired speed. This is also the control for stopping, resulting in a smooth stop, and a relaxed foot to stay stopped.

There are two reasons why acceleration is pressing down, and deceleration is raising up, rather than the opposite. The most important reason is that if the driver removes their foot from the pedal, the pedal pressure raises the pedal, resulting in deceleration until stopped. This is known as the dead man's switch. The other reason is that acceleration tends to move the driver's foot backward, and deceleration tends to move the driver's foot forward, which is stabilizing negative feedback.

Different drivers have different leg and foot weights. So when a different driver sits in the driver's seat, in addition to adjusting the seat position and mirrors, the neutral pedal position needs to be adjusted. Just relax your foot and push a button.

Safety

The great majority of traffic accidents are due to driver error, not to mechanical malfunction. Portation eliminates driver error, but malfunction is still a concern.

In a system with a central control, when that control malfunctions, the whole system malfunctions. Portation has no central control; any control malfunction is purely local.

If a box that controls the speed of a porter ceases to function, the boxes that should receive information from it immediately detect the problem, and they change their behavior in two ways. First, they start receiving speed control information from the boxes that the disabled box receives from (their identities are the two extra identities referred to earlier in subsection “General Control”). Their updates to the square speeds will use a value for x that is too small, which errs on the safe side. Second, they report the problem, including the identity of the disabled box, to all porters passing overhead. Perhaps one of the passing porters is a maintenance vehicle looking for such problems. Or perhaps every porter is equipped to pass on the report to the portway authority. It should be possible to replace a faulty box from beneath the portway, without any interruption of portway availability.

If the portway speed control stops working on a larger scale (perhaps due to an electrical disruption) so that porters stop receiving speed control information, they must automatically decelerate at the maximum allowed rate until they are slow enough to be under human control.

If a porter's speed control malfunctions in a way that causes it to decelerate more than the maximum allowed deceleration, a crash may result. But it is impossible for a crash to be head-on (porters traveling in opposite directions). Even when porters are traveling densely packed at high speed, the speed difference between adjacent porters is small, and their direction is constrained by the portway, so a crash is probably not serious. In our car culture, high speed densely packed traffic is very dangerous due to slow human reaction time and inaccurate human control. But these human limitations do not apply to portation.

For the rare case that there is an object on a portway that is undetected by a control box beneath it, porters should have forward radar to detect the object and engage the brakes. This forward radar will be most useful when porters are on the street, off the portway.

If one flange malfunctions in a merge or divergence area, the other flange on the same side can control the direction at reduced speed until the porter can exit the portway. If both flanges on the same side malfunction in a merge or divergence area, the result can be derauling.

Flanges must be engineered so well that they almost never fail.

When a section of a portway's electric power fails, the boxes in that section switch to backup battery power, and the porters on that section switch to their battery power, which is at least sufficient to get to the next exit and off the portway. If one of a porter's shoes stops functioning, the porter continues to function, but at each merge and divergence it momentarily lacks power from the portway due to the dead spot; at those moments it relies on its battery. Even if all its shoes stop functioning, its battery will carry it to a repair shop.

If a porter becomes disabled on a portway, but does not screech to a halt with large deceleration, the speed control ensures that traffic behind it does not crash into it. Traffic behind will be stuck, at least back to the last previous divergence, as happens on a divided road. Traffic ahead will clear out and empty the portway ahead of it, at least up to the next merge. A special service porter, which is not controlled by the portway's speed control, must come along that next merge, stop just after the merge, and then back in to the disabled porter, and tow it to the next exit and off the portway. If a disabled porter is pushable, an alternative might be to conscript the next porter behind it to push it gently off the next exit. (If a porter is disabled and stopped just before a merge, it should not have a ghost stopping traffic on the other branch.)

Whenever a section of portway becomes impassable, whether due to a disabled porter, portway malfunction, natural disaster, or portway maintenance, porters are diverted away from entering the impassable section by the following means. If a porter is stopped, a box under it detects this fact (by measuring its speed as 0), and communicates "impassable" to the box behind it. A maintenance engineer can also initiate this procedure by communicating "impassable" to any selected box, perhaps using a remote control. Each box receiving this message passes it back to the box behind, except as noted below. At a merge, the "impassable" message is passed back to both branches of the merge. At a divergence, if the "impassable" message comes from the left branch (regardless of whether that divergence is designated as a left turn, or a right turn, or a left exit, or a right exit), the boxes approaching that divergence change their location indicator to say "on the right branch approaching a merge"; of course these boxes are not in a location approaching a merge, but the effect is to cause all porters approaching the divergence to take the right branch regardless of their button settings. And symmetrically, if the "impassable" message comes from the right branch of a divergence, the boxes approaching that divergence start saying "on the left branch approaching a merge". The box in the "approaching" region that is farthest back does not pass the message back farther (unless the "impassable" message reaches the divergence from both branches, in which case the message is passed back farther). To restore passability, a maintenance engineer sends an "all clear" message to one of the boxes in the frontmost impassable section of the portway; this message is passed back and restores the original location indicators.

For safety, we have to ensure that every porter conforms to portation standards before it can be allowed on a portway. In principle, each porter must pass tests and be issued an identity by the portway authority. The identity is automatically detectable at each portway entry ramp; if a valid identity is not detected, the porter is denied entrance. In practice, the portway authority can delegate the testing and issuing of identities to a company that builds porters, if the portway authority deems the company trustworthy. An identity must be difficult to forge. (The porter identity is also used for billing for electricity and parking, and for summoning your vehicle.)

Portation does not require policing or traffic courts. It is possible (desirability is not discussed here) to design porters so that police can take over control of a porter's route, causing it to go where police want.

Finally under the safety heading, portation should cause fewer deaths and injuries to animals, both pets and wildlife, than cars and trucks on roads cause.

Intersection Topology

Suppose there are four portways, one going north, one going south, one going east, and one going west. The northbound and southbound portways are parallel and together, like a highway; the eastbound and westbound portways are parallel and together, like a highway. And they intersect, just like two highways intersect. But unlike highways, at the point of intersection the four portways are at four different heights. If space is a limitation, they can be in a single vertical stack. The order in which they are stacked does not matter. These portways divide the plane into four quadrants; in each quadrant there are two connecting portway segments. For example, in the north-east quadrant, one portway segment connects the westbound portway to the northbound portway, and the other segment connects the southbound portway to the eastbound portway. If there are only three portways, for example, northbound, eastbound, and westbound, then each quadrant has one connecting segment. If there are only two portways crossing, then two diagonal quadrants each have one connecting segment.

There are no cloverleaves; all connections are direct. A connecting segment curves from one direction through 90° to another direction. The curvature of a connecting segment depends on the space available and on the desired speed. If the space is small, the curvature can always be made tight just by making the speed limit slow on the connecting segment. That's the trade-off: space versus speed.

If two portways cross at an intersection, and the space available for connection is only 7m wide, the curve of a connecting portway must have a radius of at most 25m. If the space is less than 7m wide, the portways cannot connect at that intersection. If the space is at least 14m wide, there is room for both connecting portways at that intersection. If a porter is 5m long or less, its center wheels (pressing up) are less than 13cm off the center of the rails at a tight (25m radius) connection; this is within the tolerance allowed by the 30cm width of each rail. Porters longer than 5m require two pairs of wheels pressing up, one pair near the front, and the other pair near the back. Porters can also be connected or articulated.

Specification

The first task is a precise specification of the interface between portway and porter. The purpose of the specification is to enable portway designers and porter designers to work independently. It tells porter designers what they need to know about portways, and it tells portway designers what they need to know about porters.

The minimum height difference between crossing portways, and the maximum height of porters, limit each other. The minimum distance between parallel portways at the same height, and the maximum width (and length on curves) of porters, limit each other. Portway strength and porter weight limit each other. The maximum space between boxes must be less than the minimum length of porters so that a porter cannot hide between boxes where it will not be detected. The minimum distance between successive merges, turns, and exits must be long enough to allow porter flanges enough time to extend or retract when the porter is traveling at the speed limit; this can always be achieved by making the speed limit slow enough there. The length of porters and portway curvature limit each other.

Comparisons

Cars

Portways are cheaper to build than roads because the land does not need to be leveled.
Portways are cheaper to maintain than roads.

Portways do not require dedicated land; roads require dedicated land.

Porters on portways go faster than cars on roads.

Porters on portways are safer than cars on roads.

Portation capacity (people per time past a point) for a single portway at 400km/h equals road capacity for 16 lanes in one direction at 100km/h. A single portway at 100km/h equals road capacity for 6 lanes in one direction at 50km/h.

Cars on roads are more fun to drive than porters on portways.

A porter's battery does not have to take the porter far, and is charged while on a portway; an electric car's battery has to take a car far, and must be stationary for charging.

Trains

Porters are door-to-door; trains are not.

Railway tracks require dedicated land; portways do not.

Portways are cheaper to build than railway tracks because the land does not need to be leveled.

Porters on portways are safer than trains on tracks; trains derail frequently but porter wheels are enclosed on three sides by the portway and cannot derail.

Porters on portways are equally as fast as the fastest high-speed train.

Porters carry 6 people per porter; trains carry 100 people per car.

Trains are frequently delayed or stopped in winter because the movable rail that controls direction at a divergence is frozen into place. A portway has no moving parts.

Airplanes

Porters are door-to-door; airplanes are not.

Airplanes in the air are faster than porters on portways.

Porters carry 6 people per porter; airplanes can carry 200 people per airplane.

Porters are electric; airplanes use fossil fuel.

Airplanes can cross oceans; porters cannot.

Boats

Porters are door-to-door; boats are not.

Porters are much faster than boats.

Porters carry 6 people per porter; boats carry many people per boat.

Porters are electric; boats use fossil fuel.

Porters cross land; boats cannot.

Boats can cross oceans; porters cannot.

Summary

Our current land transportation systems (cars and trains) were invented more than a hundred years ago. There have been improvements since then, and there are suggestions for further improvements, but none that change the main attributes: they are expensive to build and maintain, they occupy an enormous amount of land, they require an enormous amount of power, they pollute, and they kill. In contrast, portation is relatively inexpensive, fast, small, clean, and safe. It is time to upgrade.

Portation must begin as an added transportation system. In the golden future when portation is fully established, city streets can greatly reduce their commitment to cars, making more room for pedestrians, cyclists, gardens, and children playing safely.

Disclaimer

All numbers in this essay are subject to revision. Suggestions for improvements are welcome.

History of the Project

1971 - first written

1972 January 30 - I attempted to patent it; the lawyer (Arne I. Fors of Fors, Piper, and Wilbur, Toronto) informed me that nothing here is patentable; instead he “notarized” it

1973 February 14 - sent to Hawker Siddeley; no interest

1973 - sent to Ontario Ministry of Transportation and Communications; no interest

1973 - entered “Toronto Idea” competition and displayed at Nathan Philips Square

1973 - sent to Bombardier; no interest

1980 - computer simulations programmed by Jerry Zarycki

2009 March - updated and rewritten. In the earlier version, boxes communicated with each other on wires; in this version, boxes communicate using low-power transmission.

2009 March 22 - Rhys Goldstein suggested an improvement to the direction control

2010 July 21 - submitted to Transportation Research Board; rejected on 2010 October 15

2010 - given to University of Toronto professors Baher Abdulhai and Amer Shalaby; no interest

2011 April - sent to technology writers Stuart F. Brown and Michael Moyer; no interest

2013 January - given to University of Waterloo professors William Melek, Steve Lambert, Amir Khajepour; no interest

2015 November 30 and 2016 June 11 - added artwork by Ryan Elliott

2016 September 21 - sent to Bill Gates; no reply

2017 December 6 - sent to profs Trescases and Lehn, UTEV; no reply